



Engineering the Future



WINTER SOLSTICE

NIGHT CONTACT WITH GROUND

AUTUMNAL EQUINOX

VERNAL EQUINOX



Landsat
Since 1972

NORTH POLE

By Building on the Landsat Legacy

Landsat Data Continuity Mission

January 2013

Engineering the Future

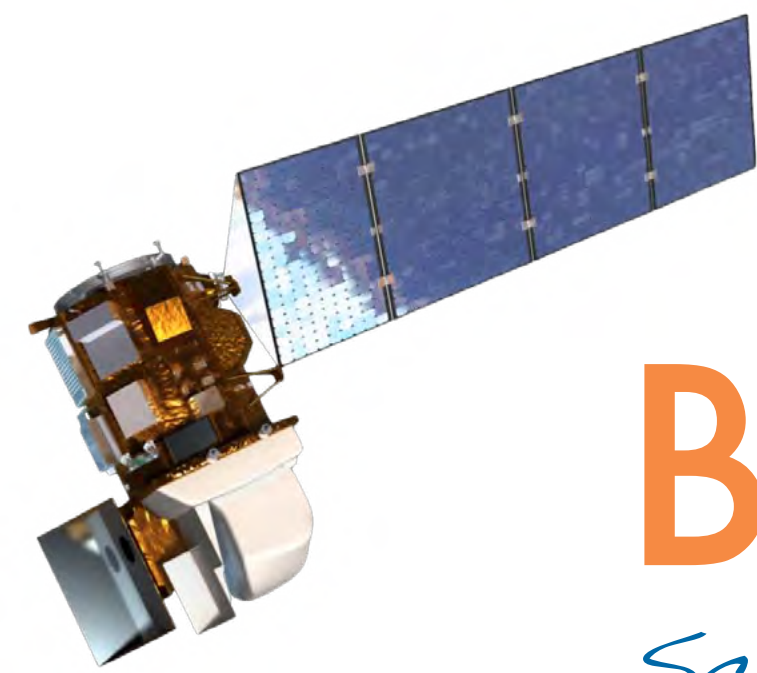

Define the Requirements

Build a satellite that:

Scientists, managers, and engineers agree on a list of requirements for the new satellite.

- + Records images that have the same level of detail as earlier Landsat satellites (30 meters per pixel)
- + Uses proven, stable, spaceworthy technology and approaches
- + Uses advanced technology when necessary to meet a design challenge
- + Matches measurements from earlier Landsat satellites by recording the same wavelengths of light
- + Is accurate and consistent
- + Measures light reflected from thin clouds and coastal water
- + Measures heat from Earth
- + Is lighter and cheaper than earlier Landsat satellites

The Engineering Process

Define the Requirements

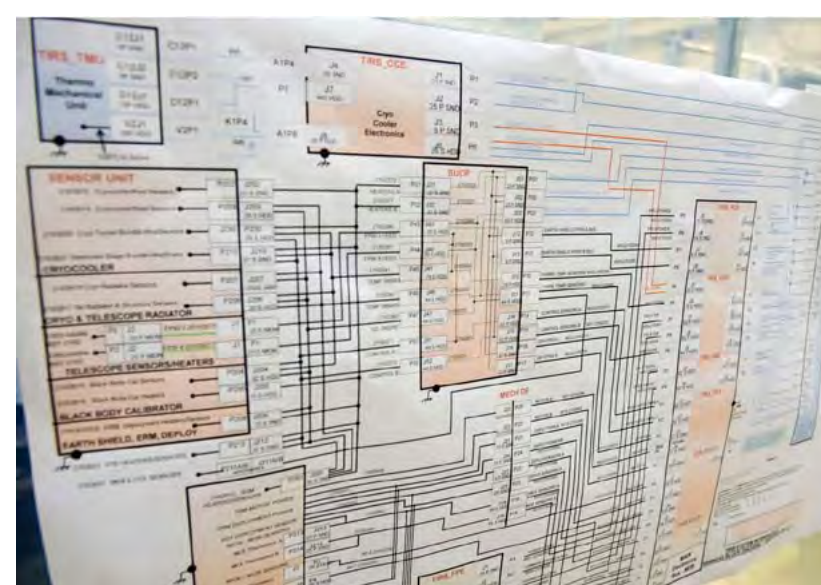

Design



Test the design



Build





Landsat Data Continuity Mission

While:

- + Staying on schedule
- + Building a spacecraft that can survive risky and extreme conditions. Loud noise and vibrations during launch can shake the satellite apart. Space brings extreme temperatures, radiation from the Sun, microgravity, no air to carry heat away, and the risk of micrometeorites
- + Building redundant pieces because if something breaks in space, it can't be fixed
- + Testing every step of the process
- + Solving unexpected challenges

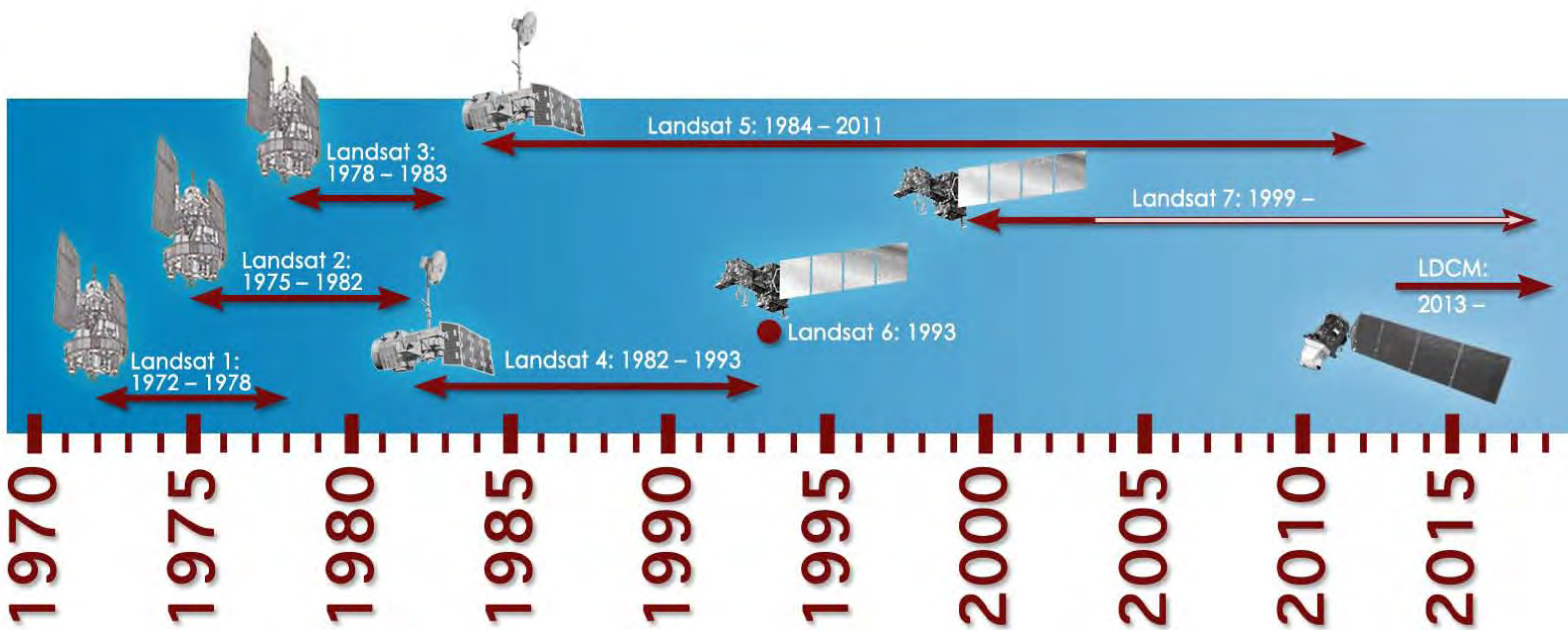
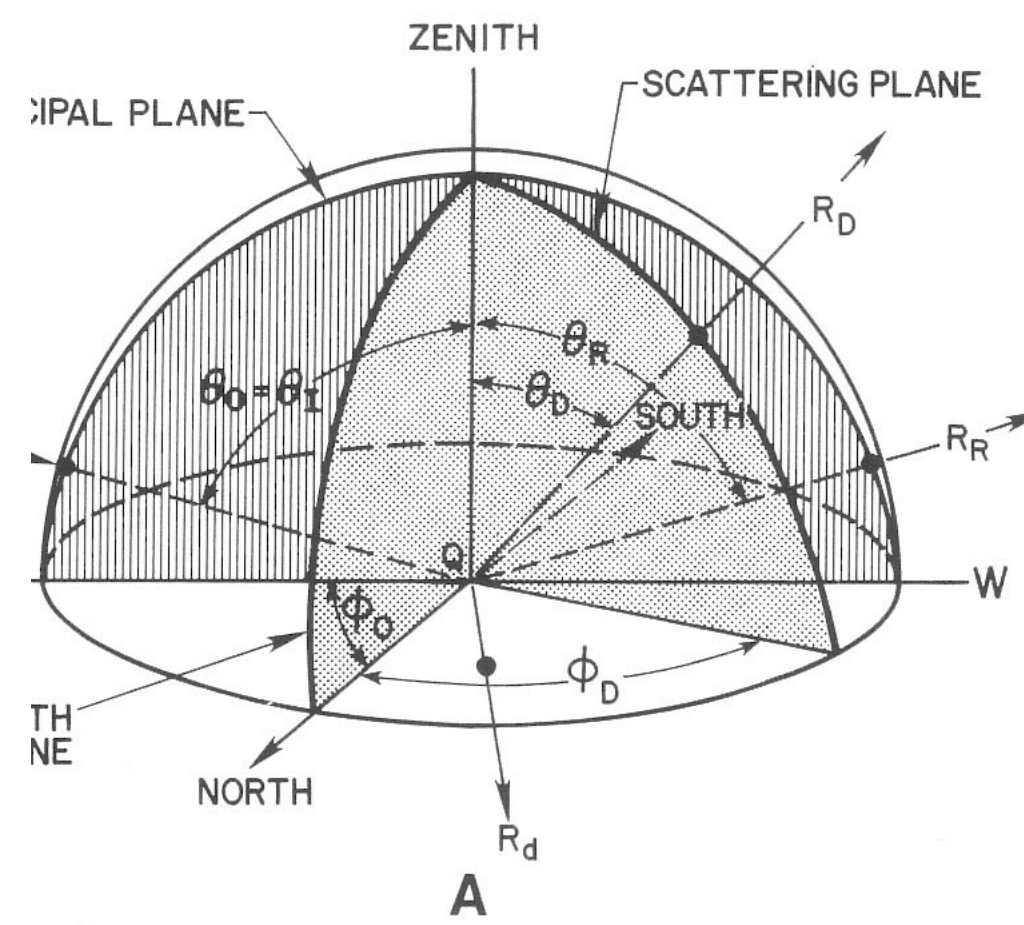

Test

Assemble

Launch

Operate

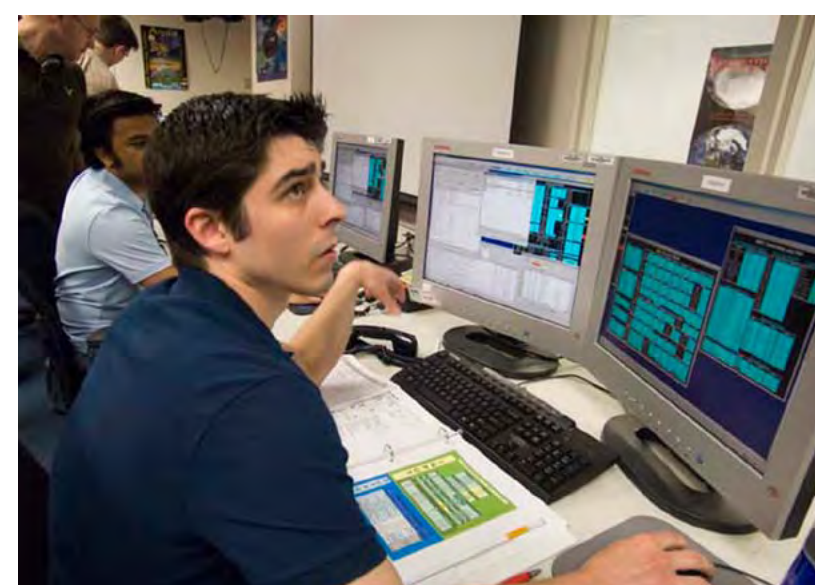

Designed to Build on the Landsat Legacy

Landsat records energy from the visible and infrared portions of the electromagnetic spectrum.

Electromagnetic Spectrum ->

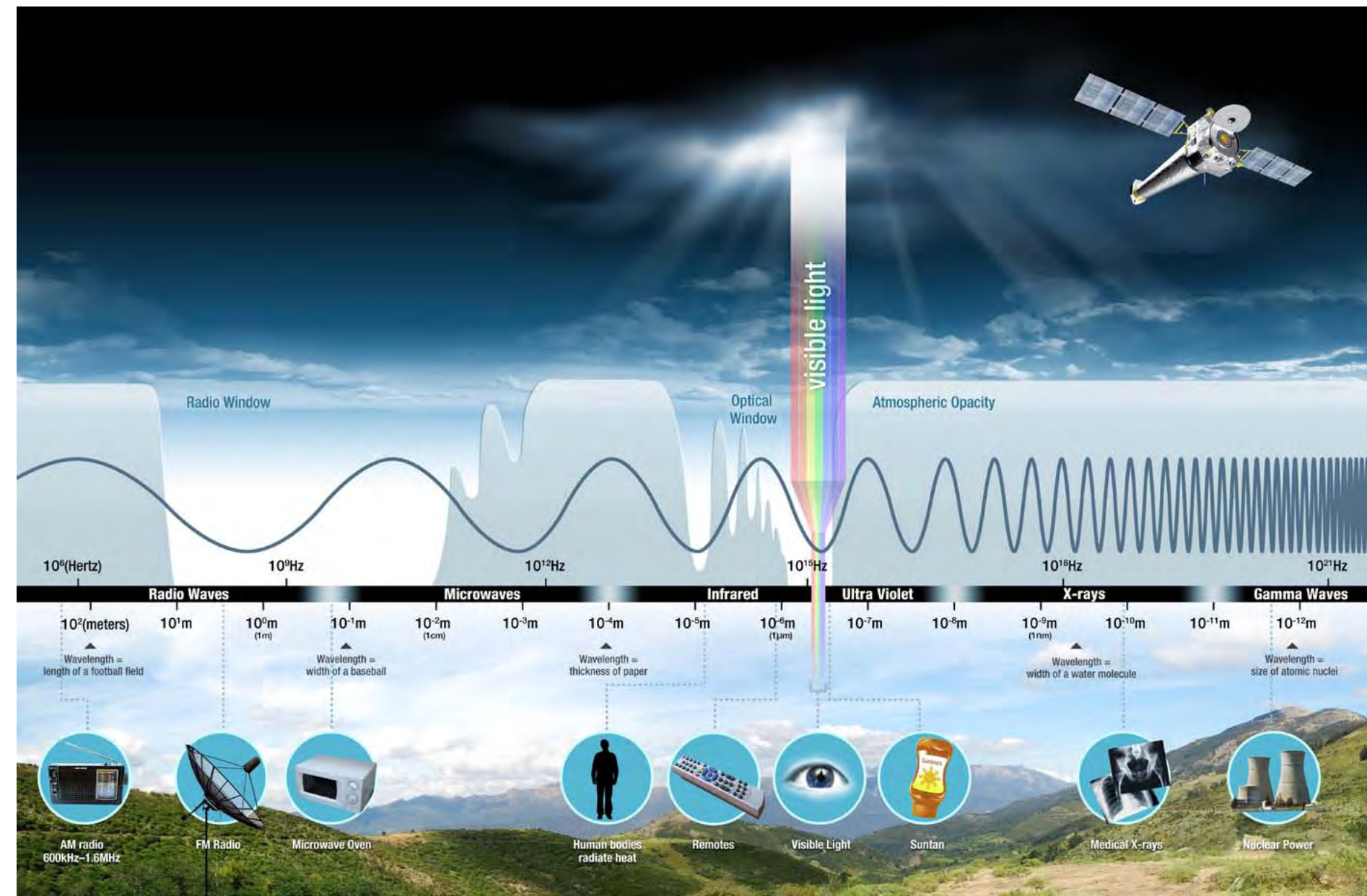

ETM+ Band	Wavelength (µm)	Color
1	0.450 - 0.515	Blue
2	0.525 - 0.605	Green
3	0.63 - 0.69	Red
4	0.75 - 0.90	Near Infrared
5	1.55 - 1.75	Infrared
7	2.09 - 2.35	Shortwave Infrared
6	10.40 - 12.50	Thermal Infrared
8	0.52 - 0.90	Panchromatic

Landsat spectral bands

Image compositing

The various spectral bands provide different information depending on how the object being imaged reflects light. To make it possible for scientists to compare new images to images taken in the past, engineers had to design the next Landsat satellite to measure the same spectral bands as previous Landsat satellites.



<- Natural color and false-color infrared aerial photographs (akin to Landsat 3,2,1 and 4,3,2 image composites). Can you find the astroturf?

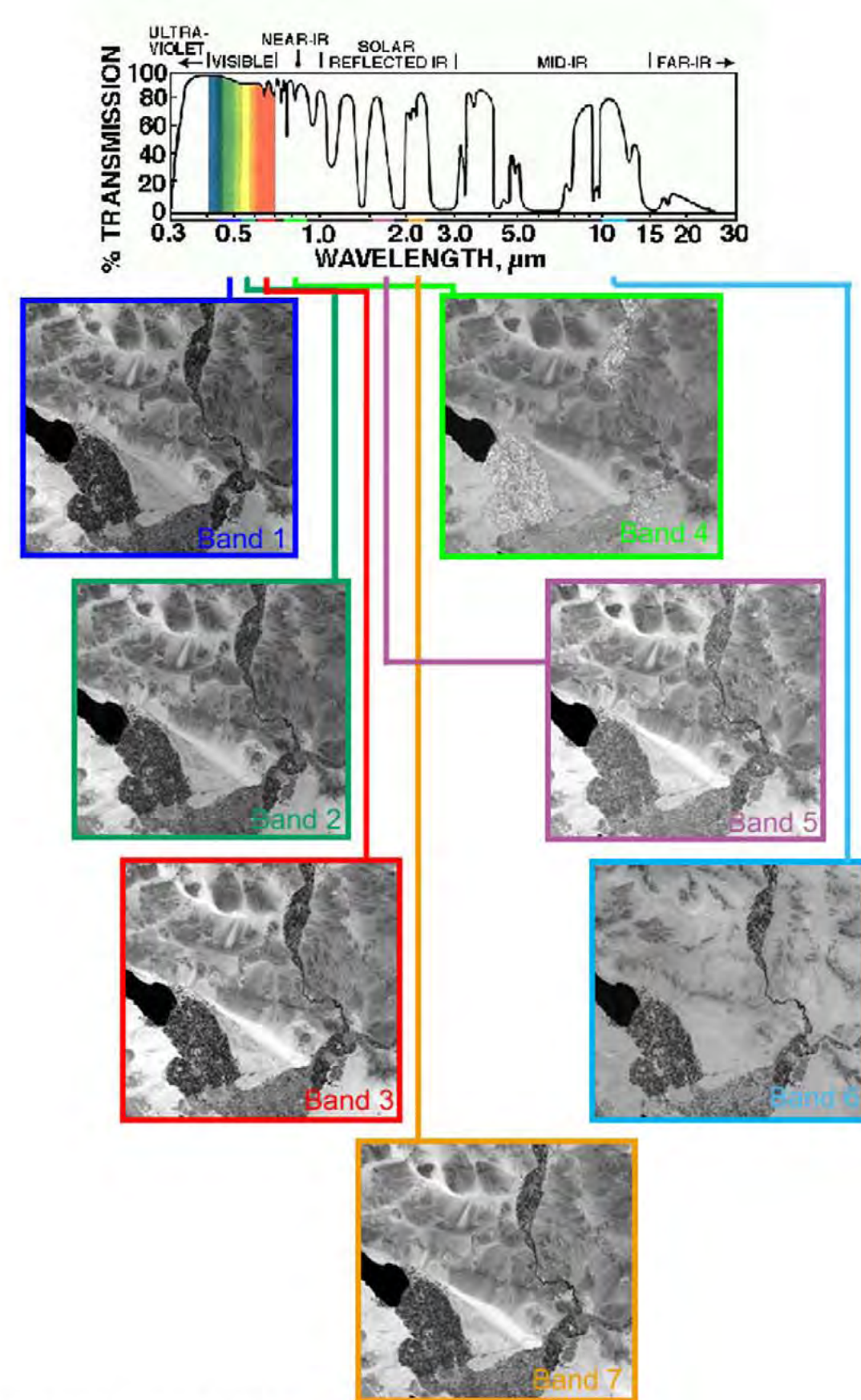

Electromagnetic Spectrum Image from Virtual Hawaii.

Landsat spectral bands

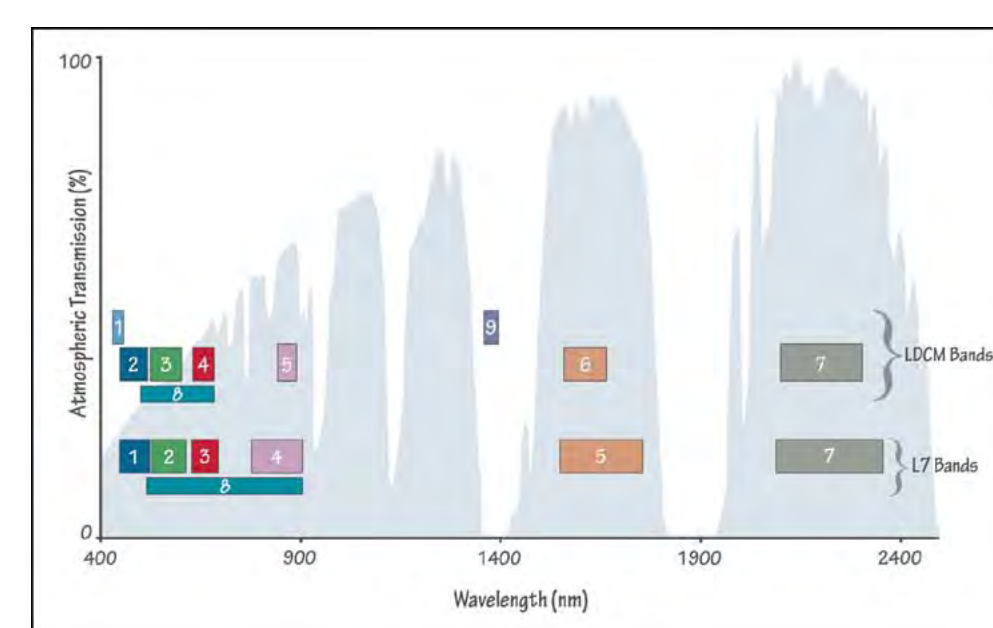

This graph compares the portions of the electromagnetic spectrum that Landsat 7 observes (lower row) to the part of the spectrum that the Landsat Data Continuity Mission (LDCM) will observe (upper row).

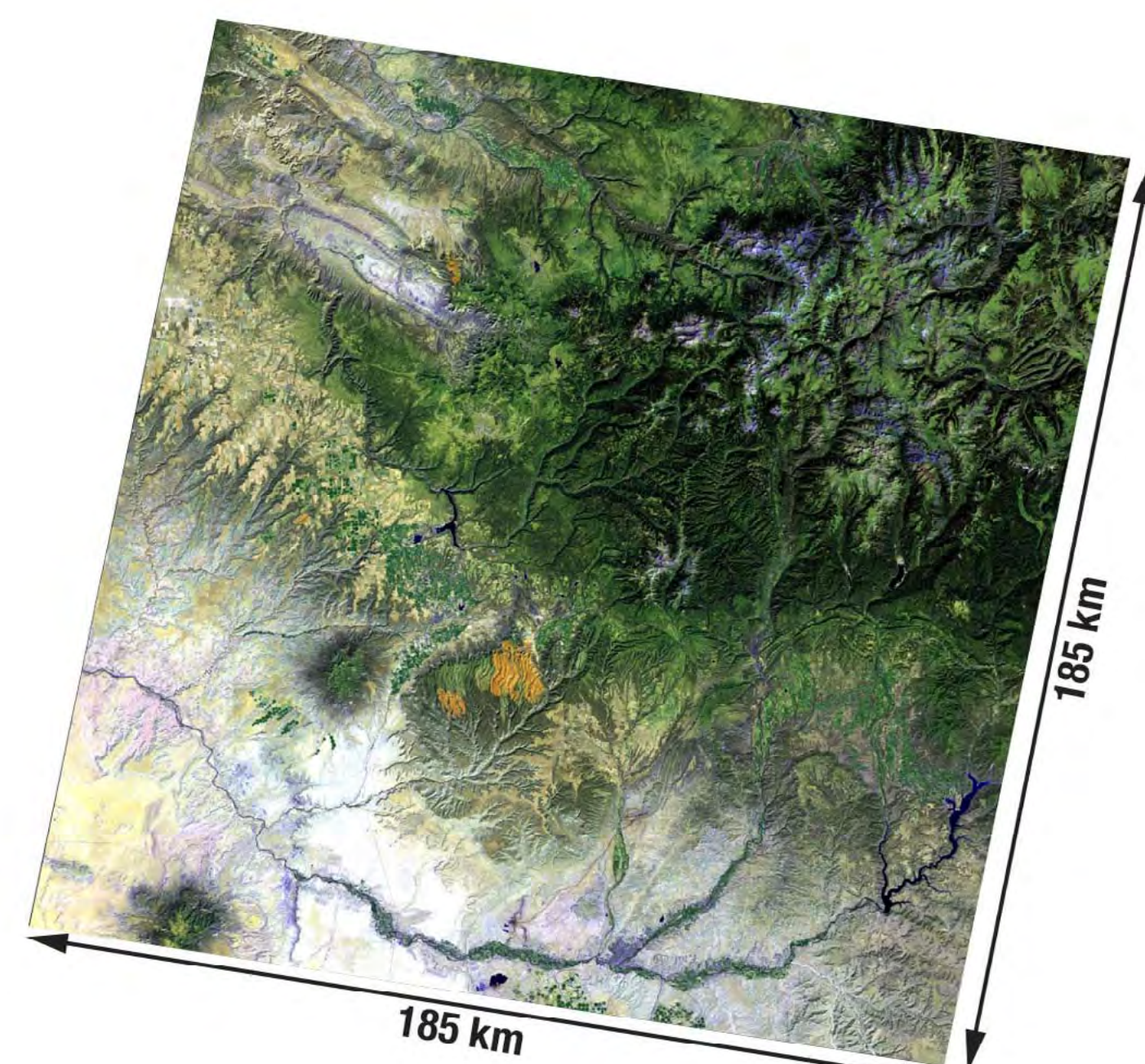

A Landsat composite using bands 7, 5, and 2. Can you find the fire scar?



Designed to See More

Two New Bands

The Operational Land Imager will see the same parts of the electromagnetic spectrum as Landsat 7 instruments. It will also see two additional parts of the spectrum. These new bands will help scientists measure high, thin clouds and water quality.



Photo courtesy Seasonal Wanderer

Requirements Met:

- + Matches earlier Landsat satellites by recording the same wavelengths of light
- + Measures light from thin clouds and coastal water

One of the new bands will help scientists measure chlorophyll concentrations (ocean color) in coastal regions. Most of the chlorophyll comes from phytoplankton, tiny plant-like organisms that live in surface waters.

High, thin cirrus clouds can be hard to spot in satellite images. Both the clouds and their shadows can interfere with measurements.

The next Landsat satellite will be able to detect these clouds better than previous Landsat sensors because it measures light in the part of the electromagnetic spectrum where the clouds are most visible.

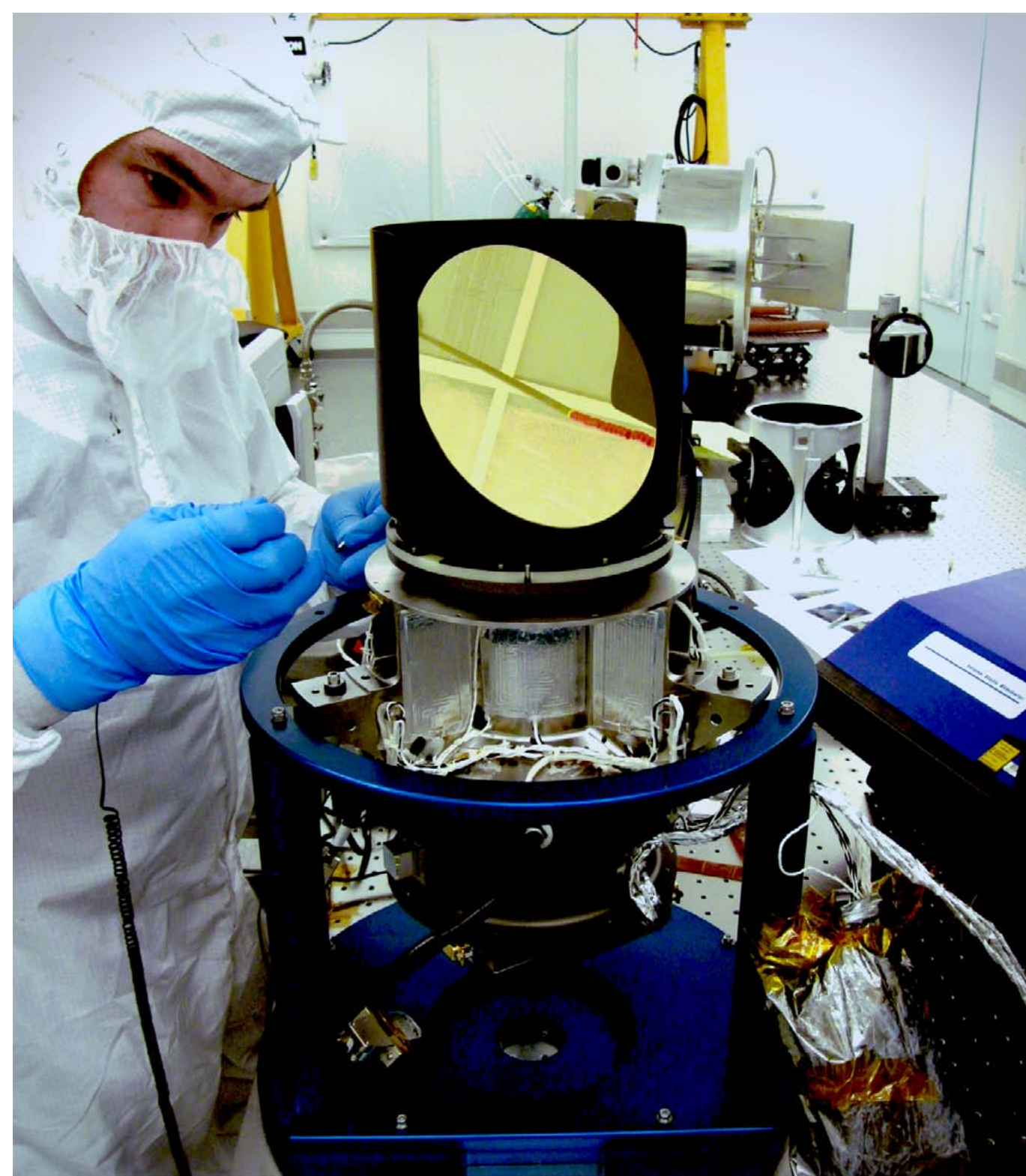

Photo courtesy Aloysius A. Gruntpuddock

Design the Instruments

Operational Land Imager

Requirement: Design a sensor that records images at the same level of detail as earlier Landsat satellites (30 meters per pixel)



“Why does this instrument look the way it does? The size of the aperture (hole in the telescope) is driven by the desire to see 30 meter pixels on the ground.”

Philip Dabney, LDCM instrument scientist, NASA Goddard Space Flight Center.



Both the Operational Land Imager (OLI) and its companion instrument on LDCM, TIRS (shown above), have an opening that is 8 centimeters wide. This design prevents the longest wavelengths of light from getting lost (by diffracting or scattering from the edges of the telescope aperture) before arriving at the sensors to make detailed measurements. OLI will see the ground with 30 meters in every pixel (square box that makes up the image). In some wavelengths of light, the sensor will see up to 15 meters per pixel. This level of detail matches earlier Landsat sensors, allow-

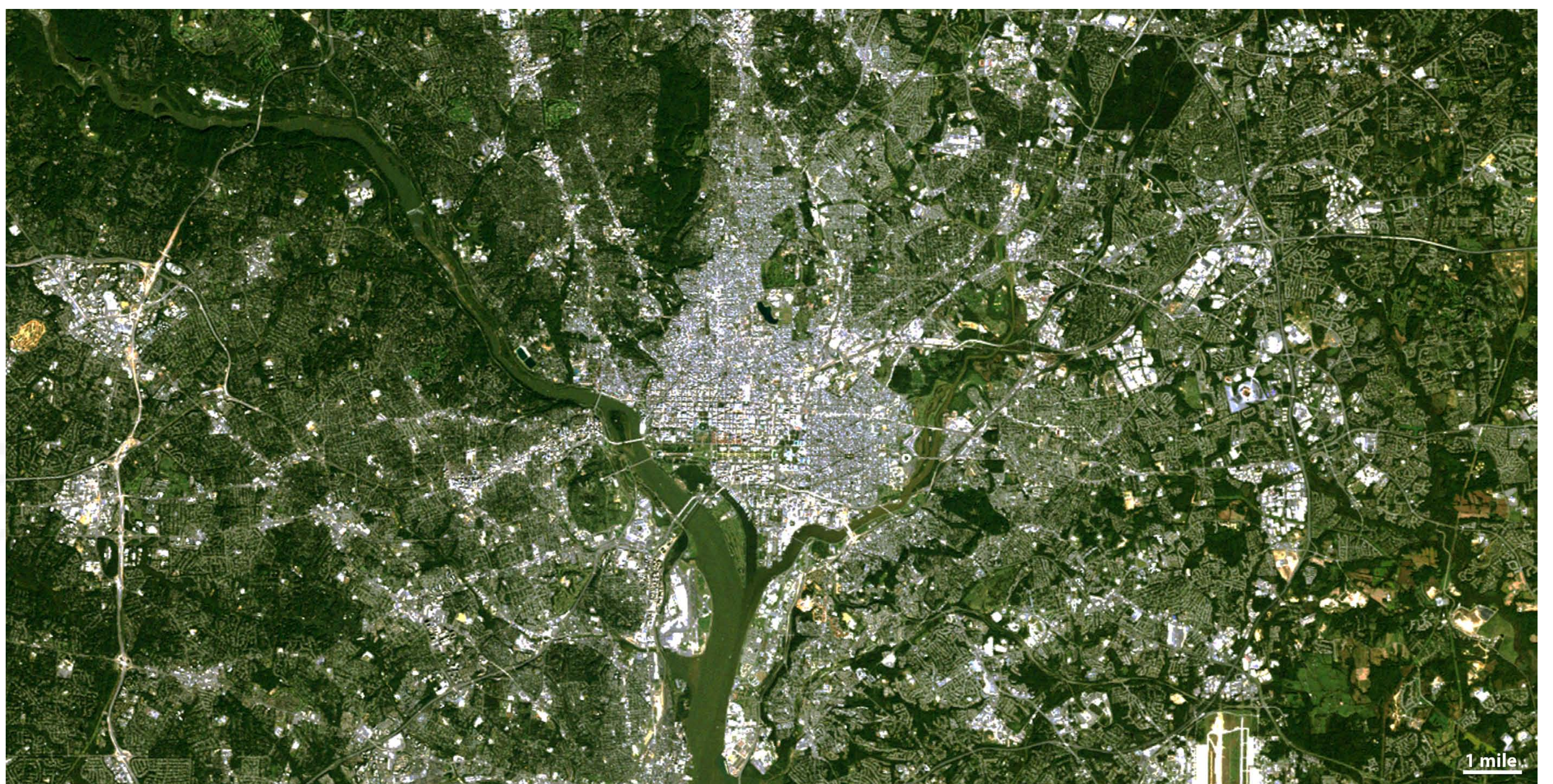
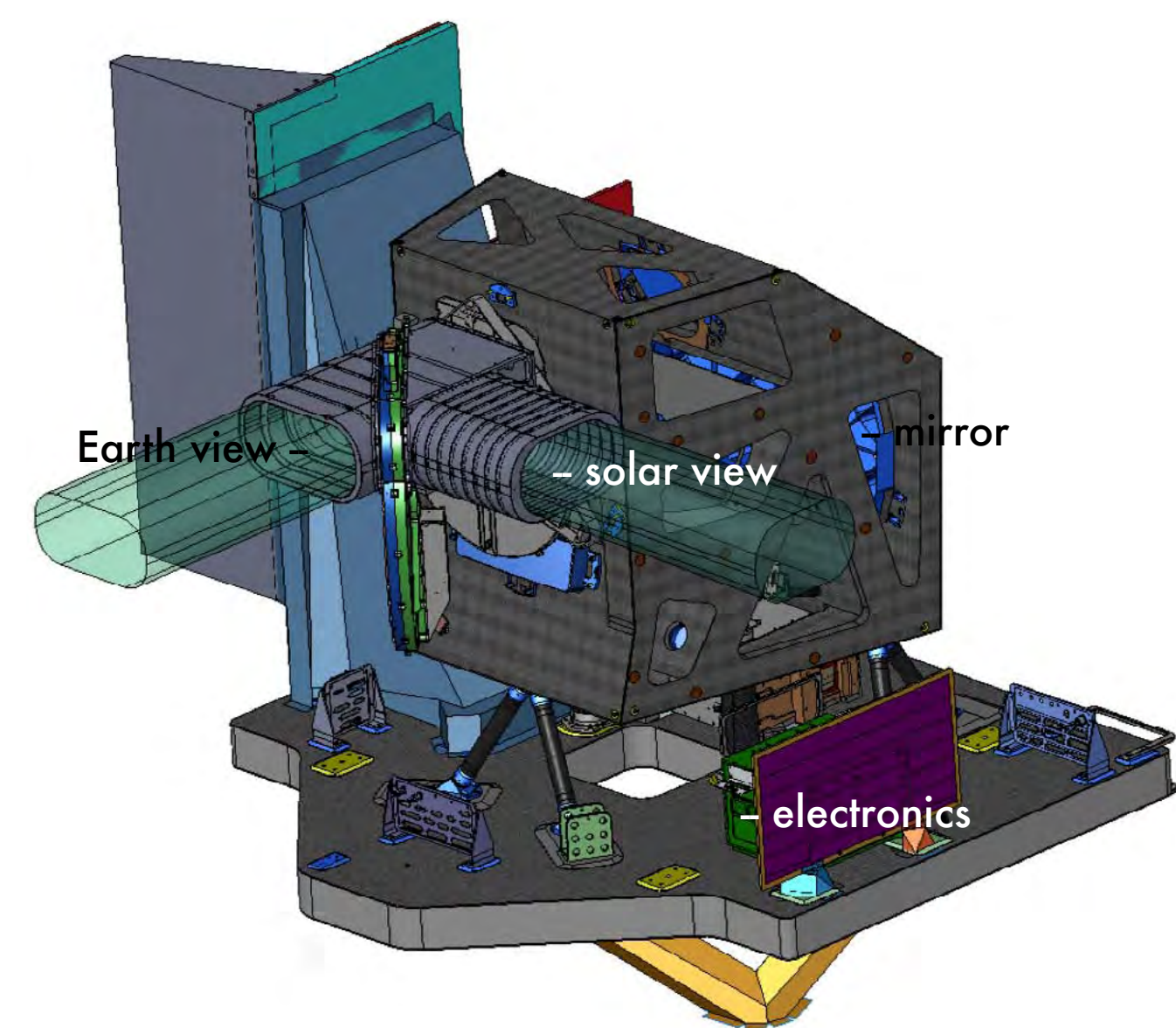

Washington D.C. at 30 meters per pixel as seen by the Landsat-5 satellite on October 10, 2011. Can you spot the National Mall or the U. S. Capitol?



Next Generation Design

The Pushbroom

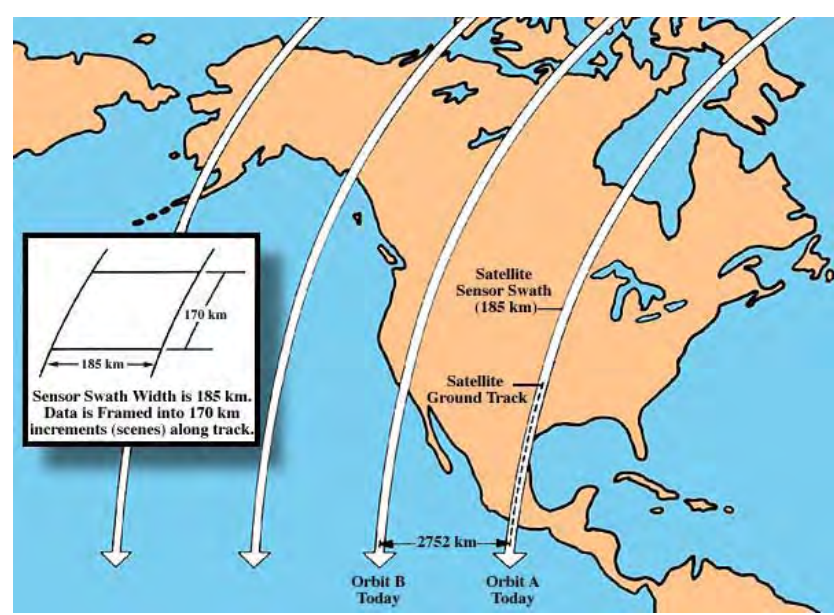

Landsat collects images in long narrow strips called "swaths." Each swath is 185 kilometers (115 miles) wide and is 2,752 kilometers (1,710 miles) from the next adjacent swath taken that day. It takes 16 days for the swaths to overlap enough to image the whole Earth.

A Landsat image is 185 kilometers (115 miles) wide and 185 kilometers tall.

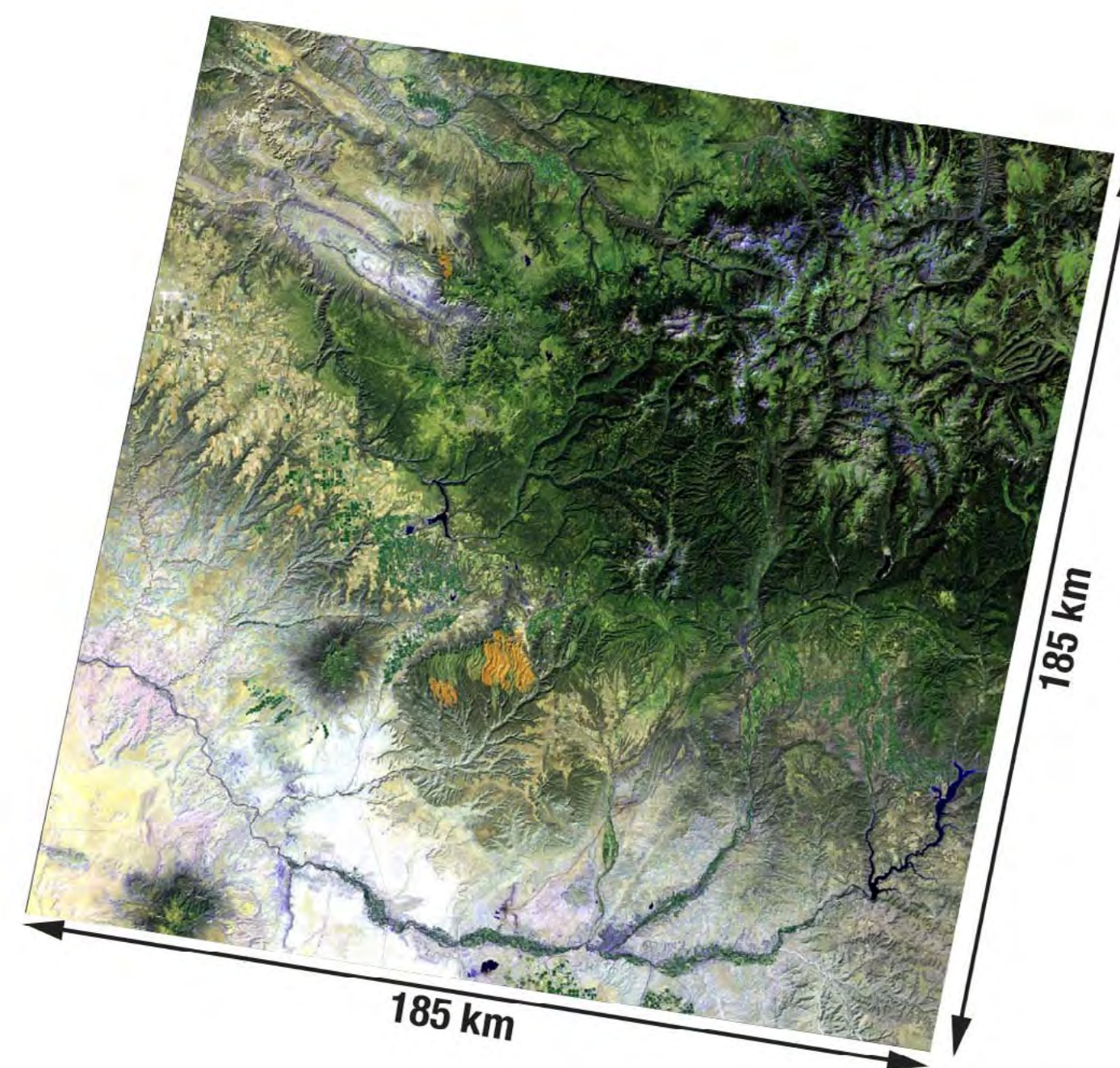

Whisk Broom vs. Pushbroom Sensor

Previous Landsat sensors swept back and forth across the swath like a whisk broom to collect data. The sensor looked at a calibration source at the end of every row, which means that measurements were consistent from orbit to orbit. But this sensor design requires fast-moving parts, which are more likely to break.

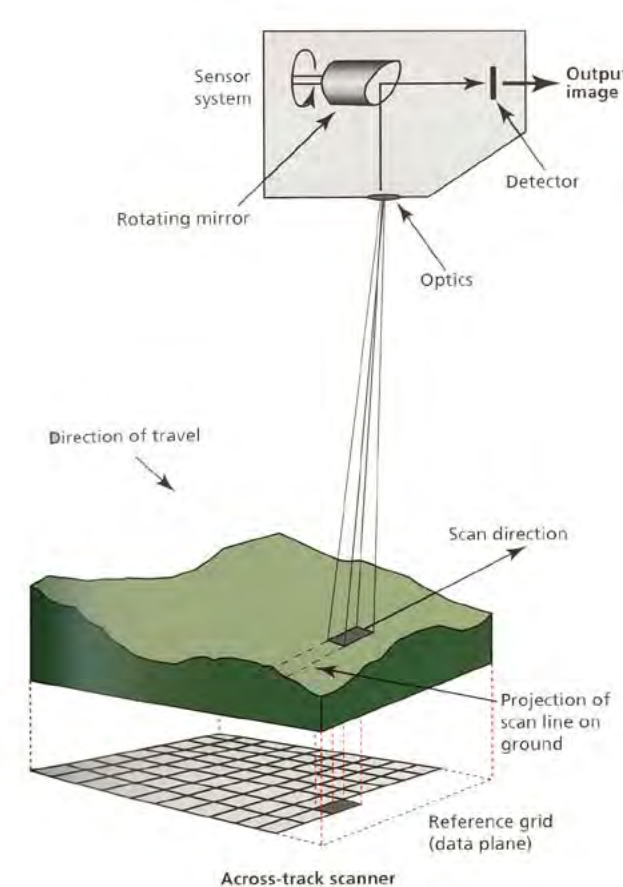

The Landsat Data Continuity Mission (Landsat 8) will view across the entire swath at once, building strips of data like a pushbroom. This approach requires no moving parts. The pushbroom sensor is smaller and lighter than whisk broom sensors, but is harder to calibrate.

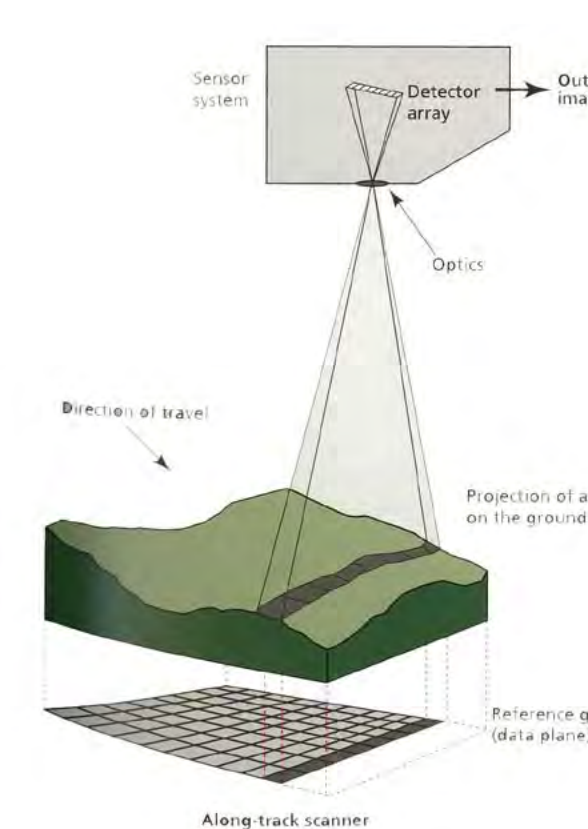

"It was a natural step to evolve to a pushbroom sensor. The technology was proven on other satellites, and we knew we could get better accuracy. The pushbroom has no moving parts. It is a newer and more reliable technology. The smaller LDCM spacecraft was not suitable for another new whiskbroom sensor, even if it was a new design. We needed a smaller sensor, and the pushbroom is smaller and lighter than a whiskbroom sensor." Terry Arvidson, senior project engineer

Testing Reveals Problems

Stray Light

The pushbroom design allows more light to enter the telescope, introducing the problem of stray light.

What is stray light?



Photo courtesy drivebybiscuits

Have you ever felt blinded when looking through a dirty, scratched, or wet window? The dirt or water scatters light, so you get sunlight in your eyes even if the Sun isn't directly in front of you. This is an example of **stray light**.

Because the Operational Land Imager has a pushbroom design, it has a wide focal plane--the place where the light enters the sensors. Because the plane is wide, it is easy for light to enter from many directions. This scattered light "blinds" the sensor to what it is trying to see directly below.

Scattered light, or stray light, is a problem especially when trying to image a dark-colored forest or water next to a bright cloud or snow field. Light from the bright surfaces can "blind" the sensor to the dark features nearby. Imagine trying to study details in the grass or forest in this photograph, and you can understand why stray light is a serious problem.



"One kind of stray light is an unwanted image in a place you don't expect it. The term for that is ghosting." Frank Grochowski, Ball Aerospace Technologies Corporation.



Photo courtesy The Doctr





And Uncovers Solutions

Isolate the Problem

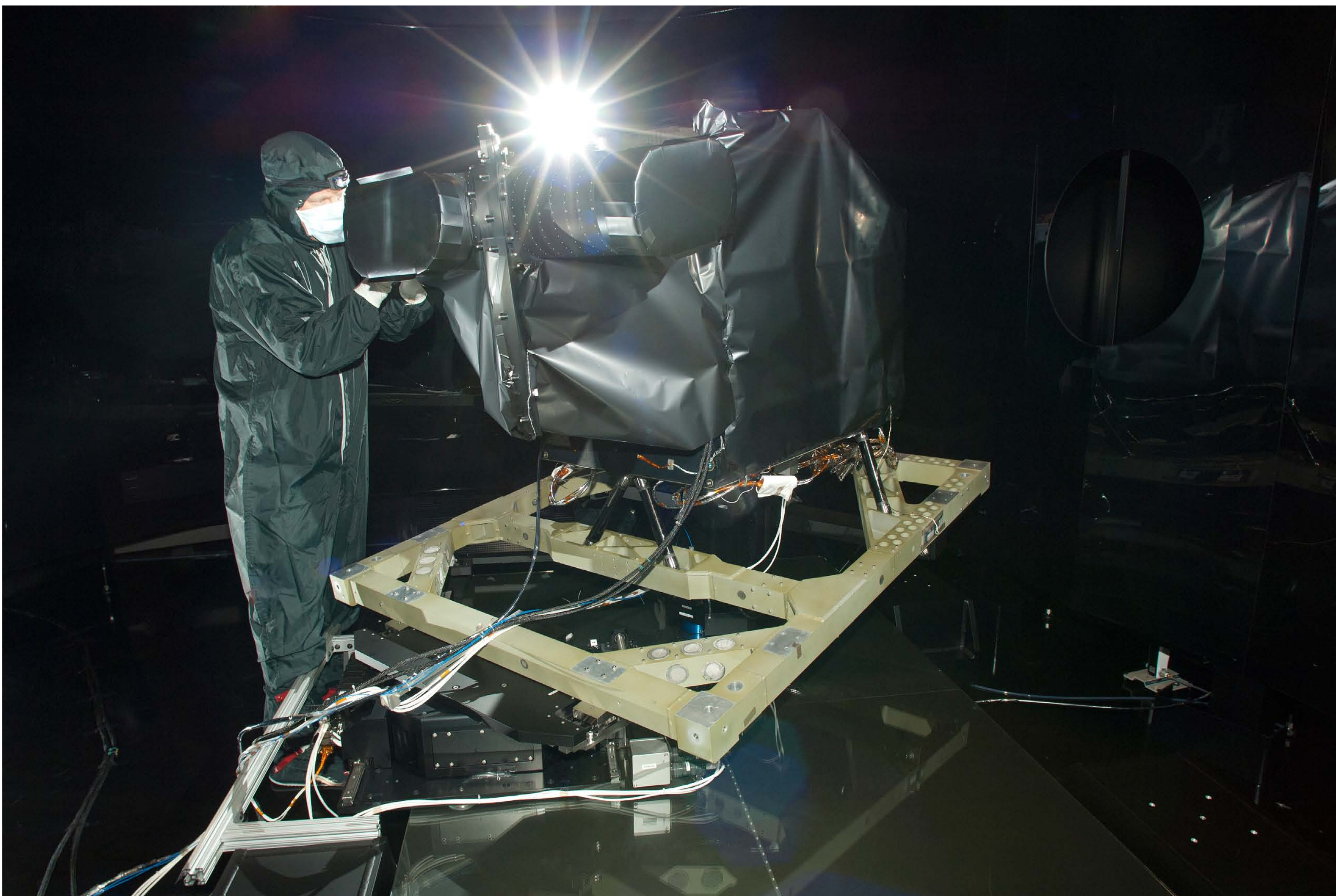

Ball Aerospace

Engineers at Ball Aerospace design a special test facility to test the Operational Land Imager (OLI) for unwanted stray light. The room is completely dark except for a single light source. This allows engineers to see where light goes when it enters the sensor. They move the light source around the sensor. The goal is to ensure that light enters the sensor only when it is directly in front of it. Engineers minimized stray light in the OLI sensor by putting a tilted window in front of the focal plane, where light enters the sensors.

Engineers also placed a black chrome-coated baffle in front of the telescope to limit the light that enters the sensor. The oblong-shaped baffles are prominent features on the OLI sensor, left. The baffles have thin vanes inside to help deflect stray light. The material itself absorbs light coming from everywhere but straight down. The little light that does scatter off the black chrome surface moves very predictably. The second baffle, facing right, is for calibration.

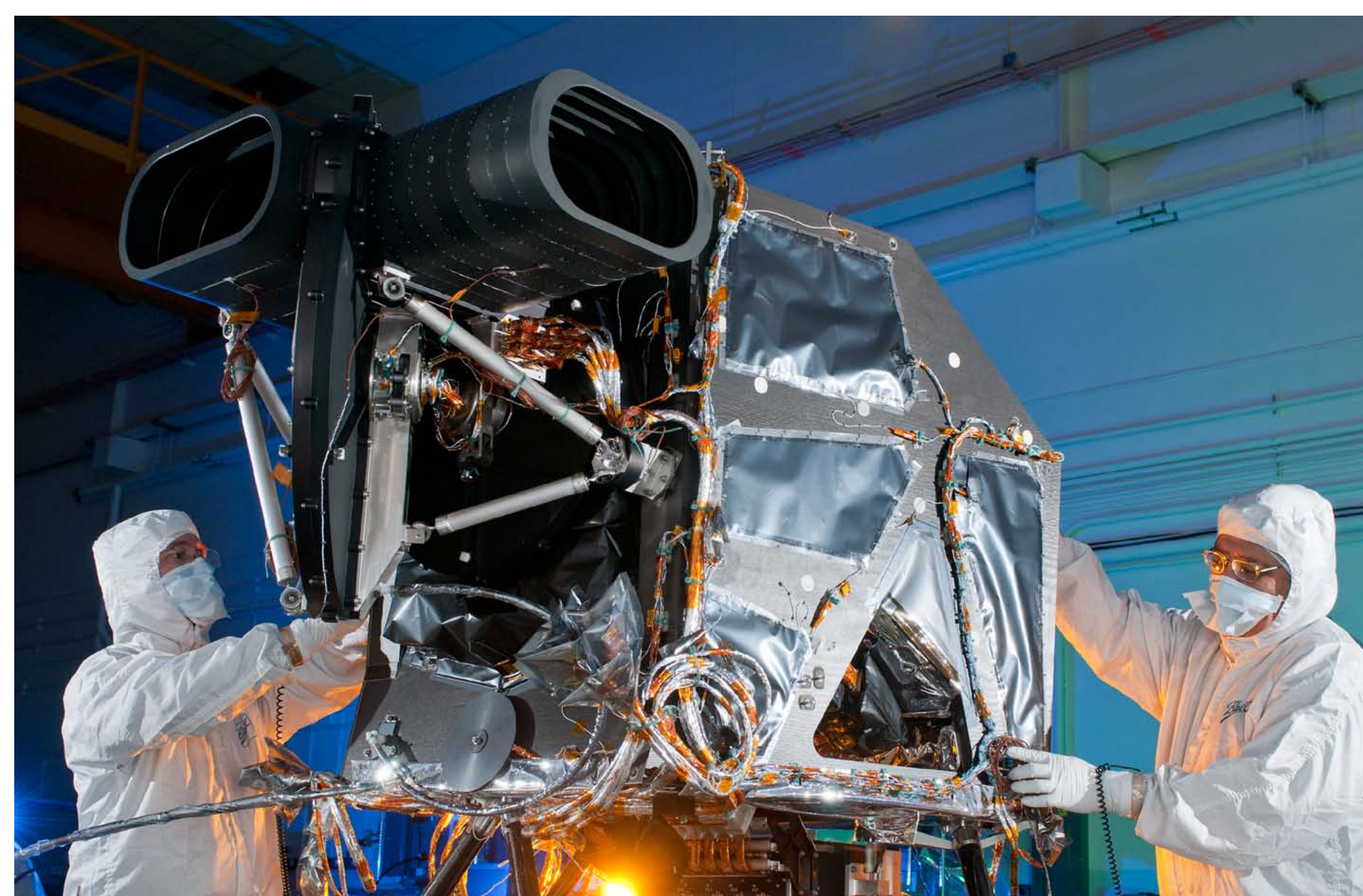

Design the Instruments

Thermal Infrared Sensor

Requirement: Design a sensor that measures heat from the Earth

Why?

By measuring heat, Landsat sensors can gauge water usage.



"We are now able to pinpoint water consumption on a field by field basis, which has never been possible before." Rick Allen, hydrologist, Un. of Idaho



To our eyes, green fields of crops all look similar. But these fields in Idaho differ from each other in the amount of water they are using.

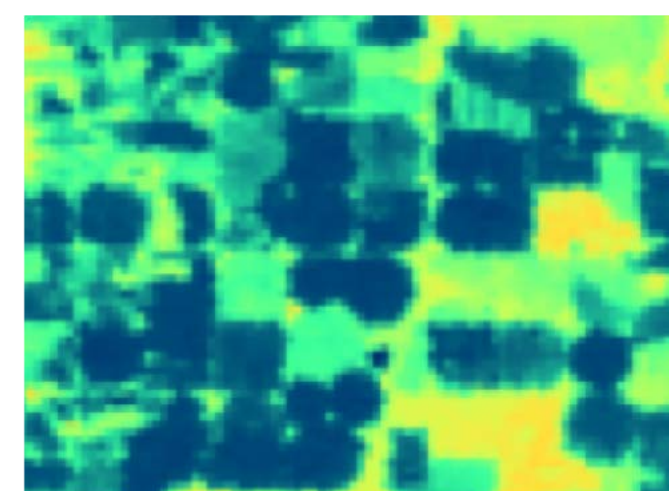

Thermal measurements from Landsat 5 show that the crops have different temperatures.

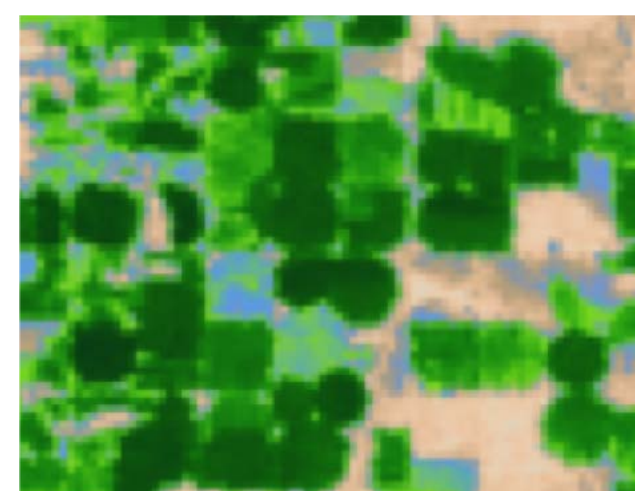

Crops that use water transpire it, which cools the canopy. Crops are using more water in the cooler fields.

How?

Design and build a sensor that detects thermal infrared energy as well as earlier Landsat satellites.



We can't see heat, but we have cameras that measure infrared energy. The camera that took these photos uses the same technology as the new Thermal Infrared Sensor (TIRS) on the Landsat Data Continuity Mission. Notice that the room is cooler (darker) than the people. Noses are often cooler than the rest of our face. The woman's glasses are black because thermal infrared light does not pass through glass.

Everything on Earth emits thermal infrared radiation. The amount of emitted radiation depends on the temperature. Thermal infrared sensors have flown on both Landsat 5 and Landsat 7. The decision to add a thermal infrared sensor to the Landsat Data Continuity Mission came late. Engineers at NASA Goddard Space Flight Center had less than four years to design and build the Thermal Infrared Sensor (TIRS). They did it.

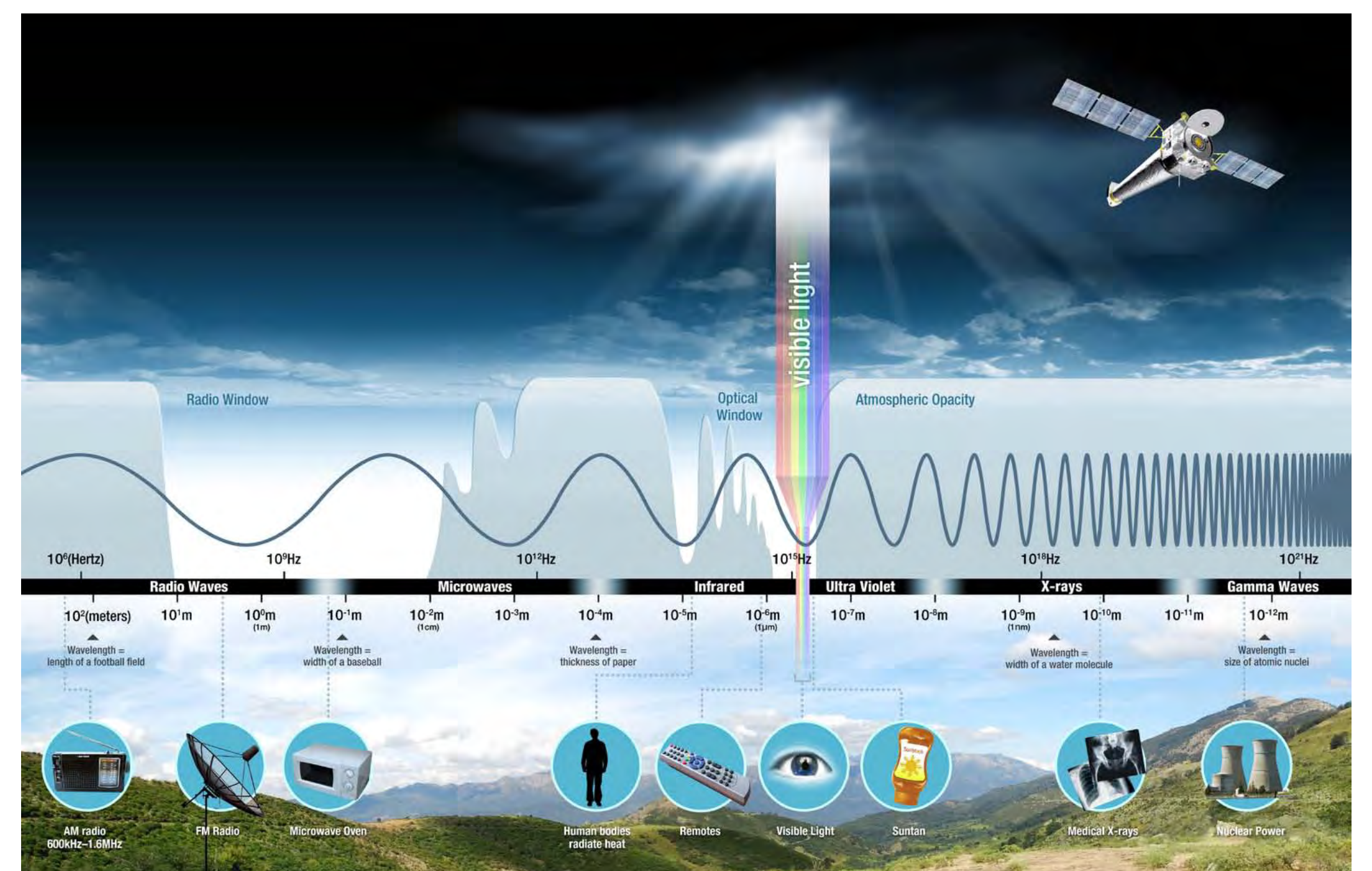



Next Generation Design

Quantum Well Infrared Photodetectors

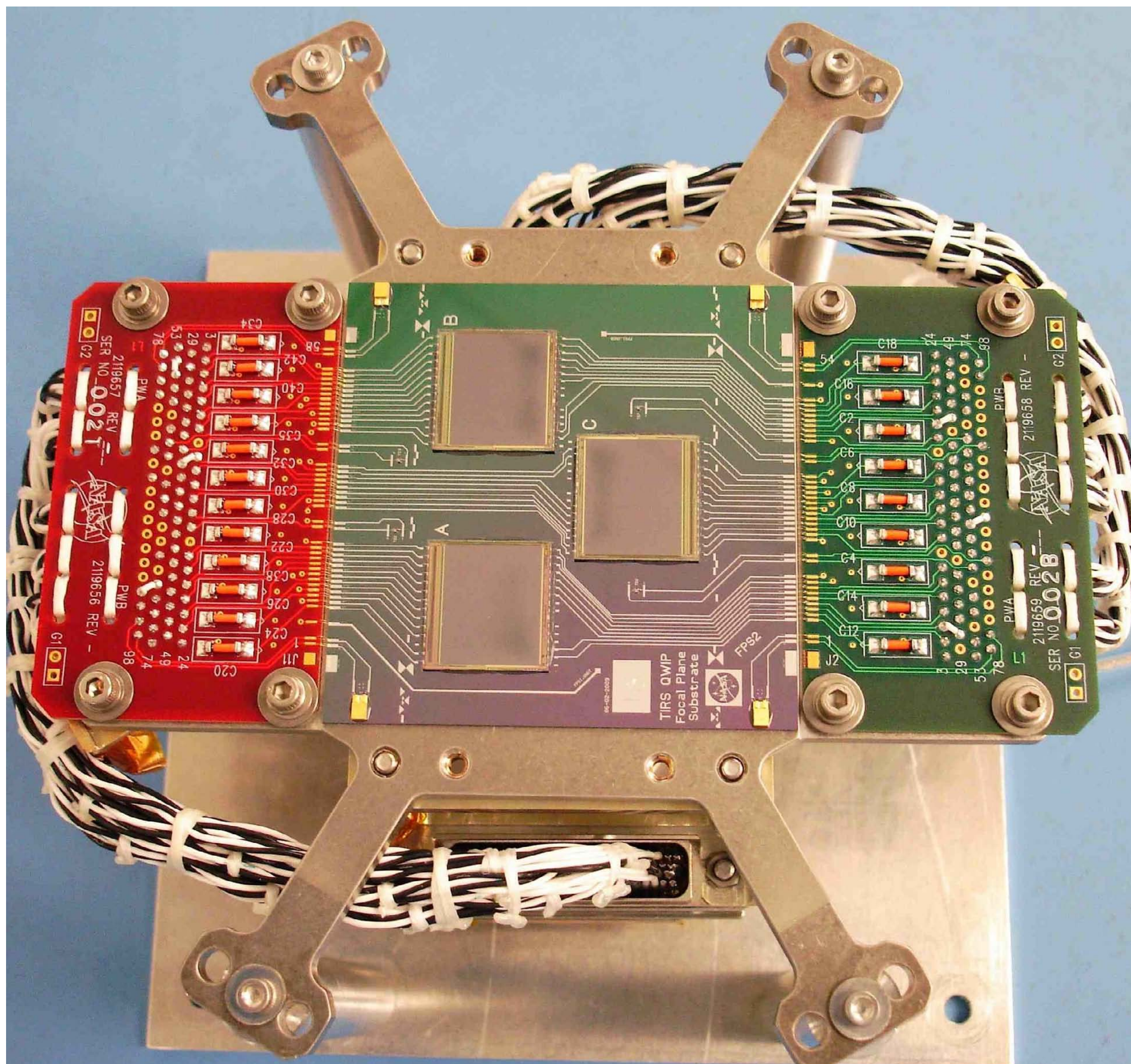

"The Quantum Well Infrared Photodetectors, or QWIPs, are light traps." Philip Dabney, LDCM Instrument Scientist

Why QWIPs?

Because engineers had less than four years to design and build TIRS. They turned to QWIPs, a new technology that had been developed at Goddard.

QWIPs are made from material that is compatible with silicon processing, meaning that the same tools and facilities used to build computer chips can be used to build QWIPs. They are very reliable, uniform, and well-suited to TIRS' requirements. Engineers at NASA Goddard knew how to work with QWIPs and could build the instrument in the short time available.

The three squares in the center of the circuit board are QWIPs, which are gallium arsenide semiconductor chips. Each QWIP can measure 327,680 pixels. The QWIPs on TIRS detect two narrow segments of the thermal infrared spectrum.

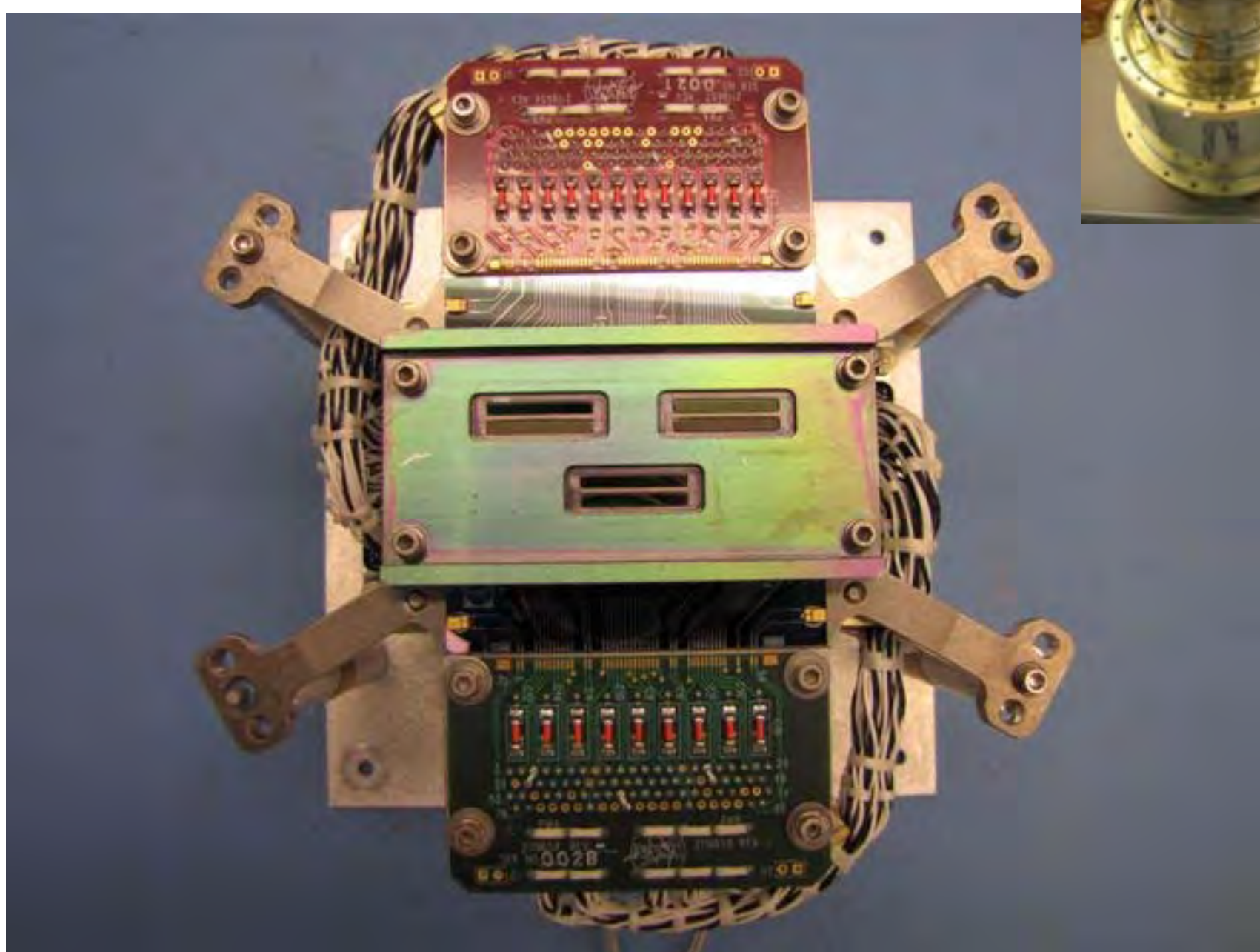

A frame containing optical filters is placed over the QWIP sensors. The filters only allow certain wavelengths of thermal infrared light to enter the sensors. The entire package (called the focal plane) is mounted in the base of the telescope, the circular lenses shown above.

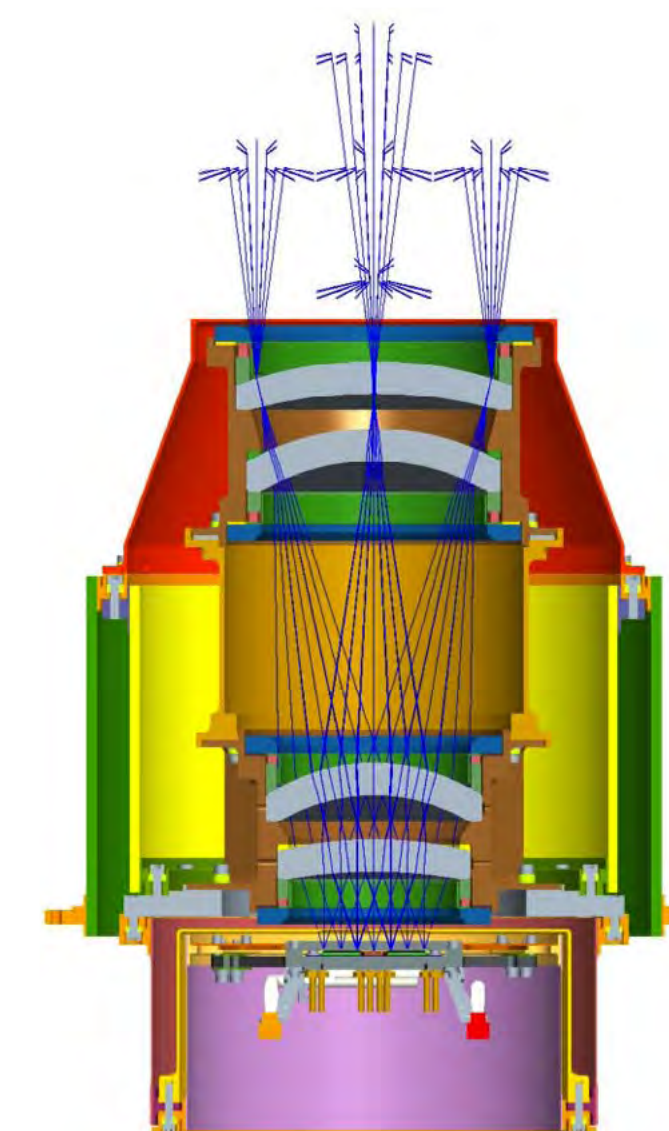

After light from Earth enters the telescope, lenses focus and direct the light through the filters, and into the QWIP sensors.



Creative Problem Solving

The decisions made to keep the QWIPs cool are an example of how engineers solved problems to build the LDCM satellite.

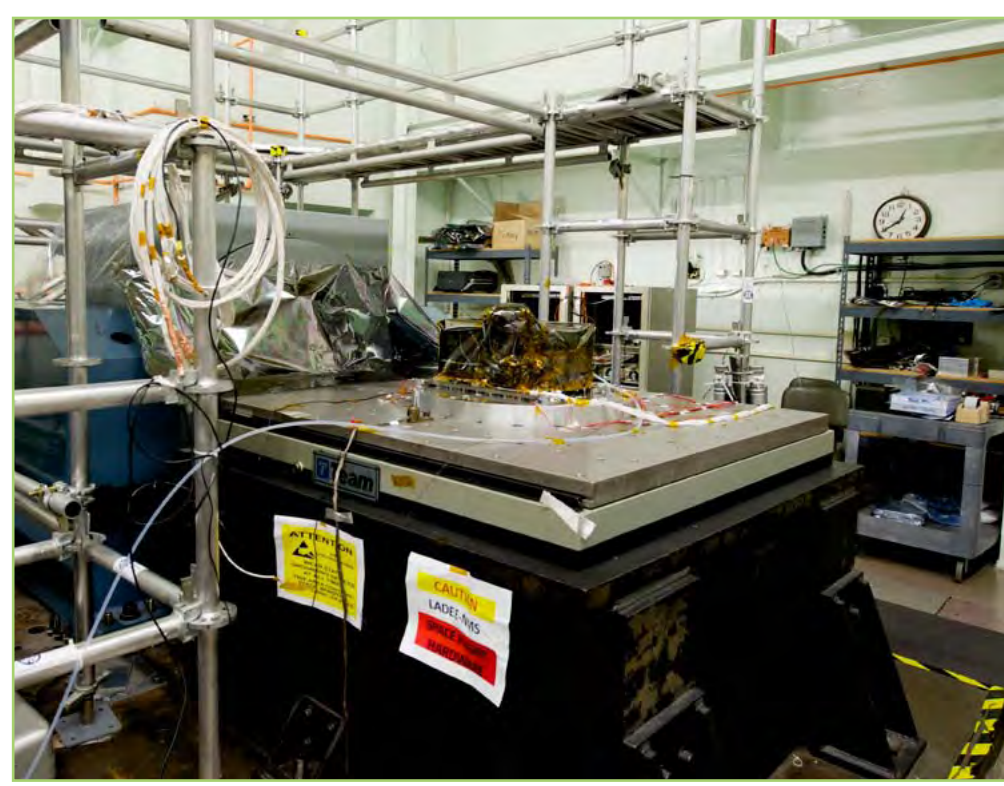

Engineers put the cryocooler and new shock absorption system on a shaker table that simulates a launch. The new shock system absorbs vibrations too strongly. Analysis and testing show that the absorption system would not survive the intense shaking of launch.

Engineers add a release mechanism to secure the cryocooler shock absorber during launch. Three pins are designed to release when sent an electronic signal.

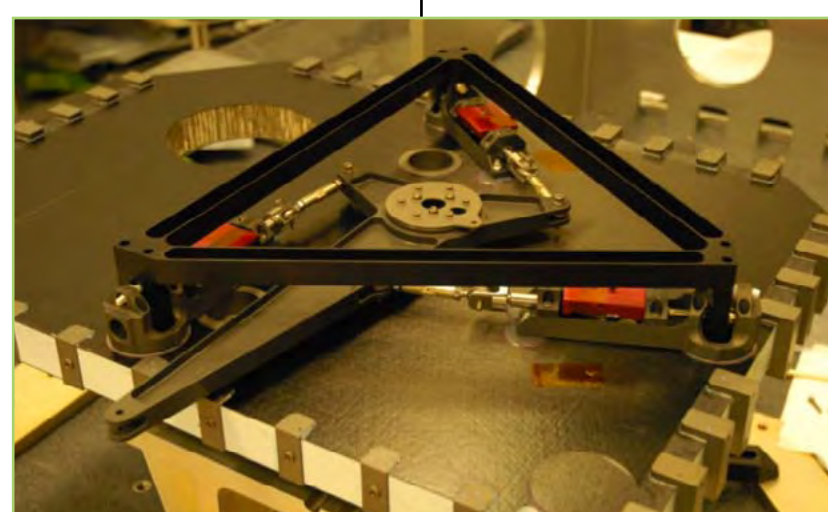

The TIRS electronics box was not originally designed for the extra wiring required for the shock absorber system. Engineers use existing mechanism electronics to trigger the release.



Engineers succeed in solving these and other problems to complete TIRS in just three years.



The new shock absorption system has to be integrated into the already built Thermal Infrared Sensor instrument without changing its mass or power requirements. It has to be completed in a matter of weeks to be included on the instrument



The TIRS engineering team at NASA Goddard Space Flight Center.

The Test and Build Cycle

QWIPs need to be very cold, 43 Kelvin, to function. That's just 43 degrees above absolute zero, -382 degrees Fahrenheit or -230 Celsius.

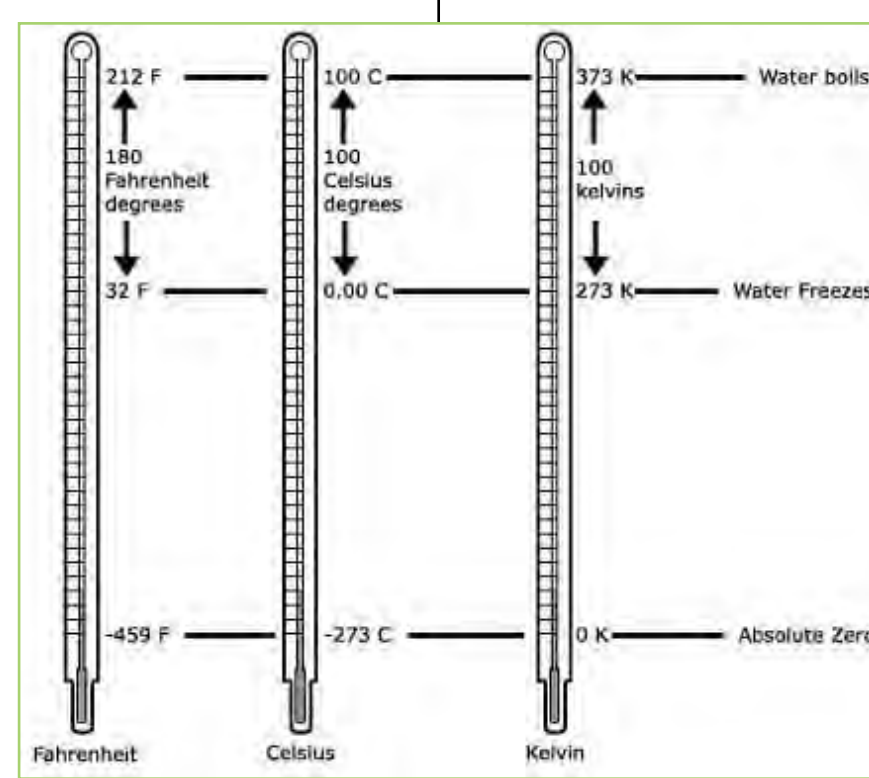

Thermal tests in a vacuum chamber show that the QWIPs get too warm. The metal they are mounted on does not transfer enough heat from the sensitive detectors.

Engineers add extra glue between the QWIPs and the metal plate. The glue helps to keep the QWIPs cool by providing an additional path for heat to leave.

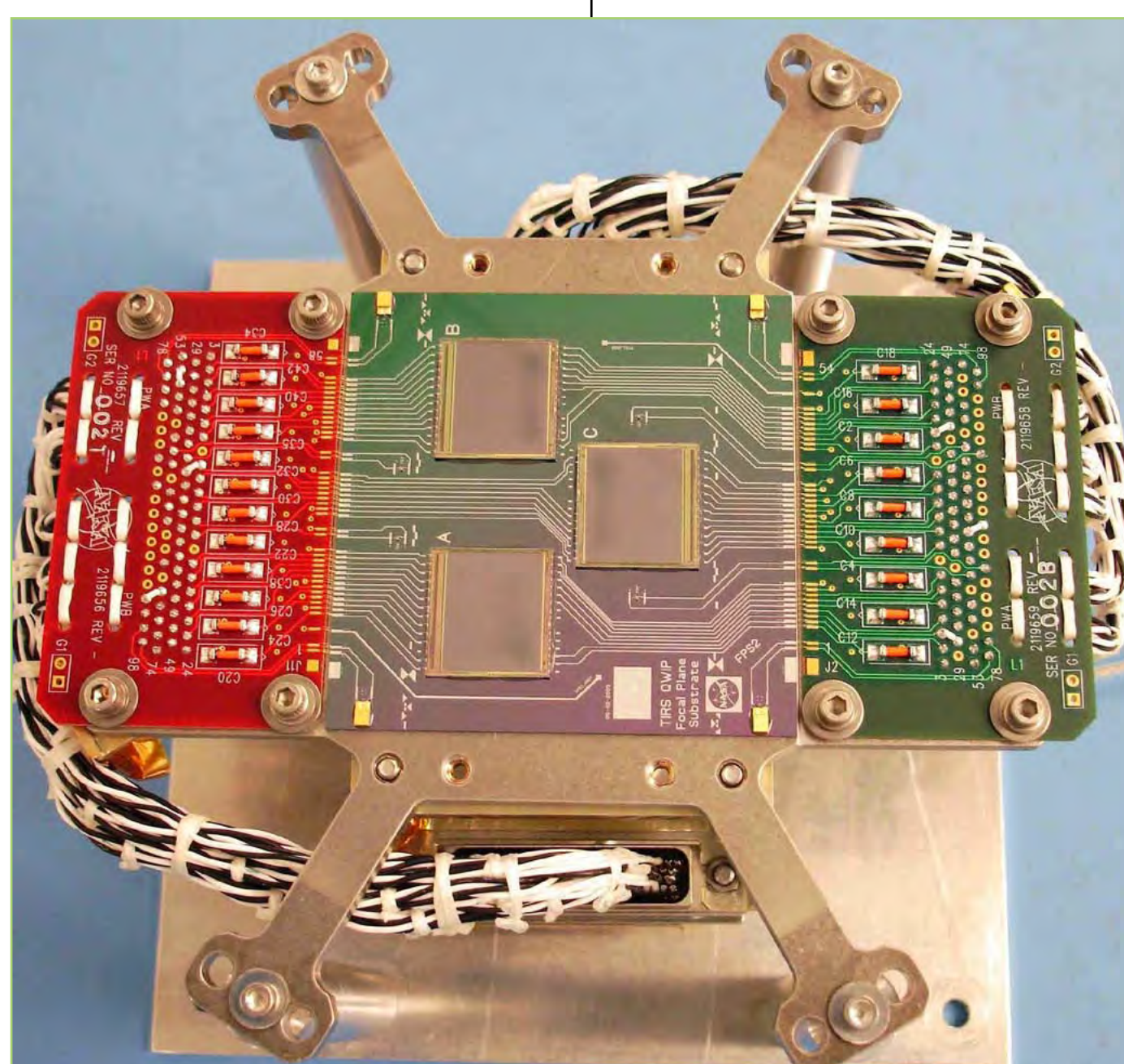

Because the QWIPs use electricity, which would make them get warm, engineers realize that the QWIPs will need a cooler to maintain the required 43 Kelvin temperature. They design a cryogenic cryocooler. The cylinders are filled with helium to provide this extreme temperature control.

When turned on, the cryocooler shakes, much like your refrigerator at home does when it is operating. The motion would make it impossible for LDCM's instruments to take clear images. Engineers design a shock absorption system that attaches to the cryocooler at the bottom of the TIRS instrument.

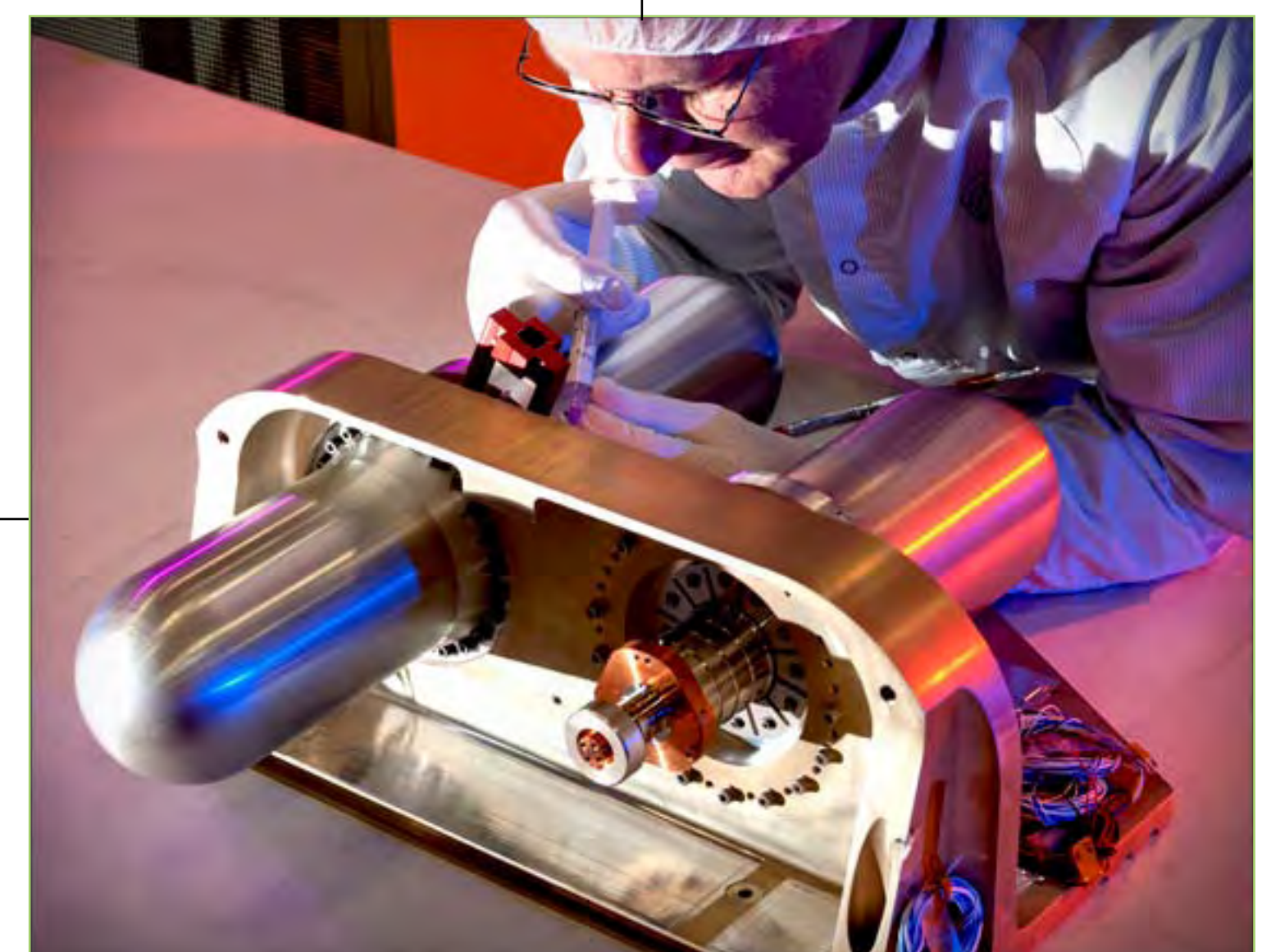

Putting the Pieces Together

Build, Test, Integrate

Build a component

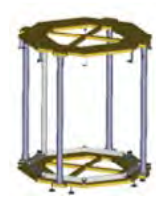

Test it

Integrate it with other components



Test them together

Integrate the group with other groups

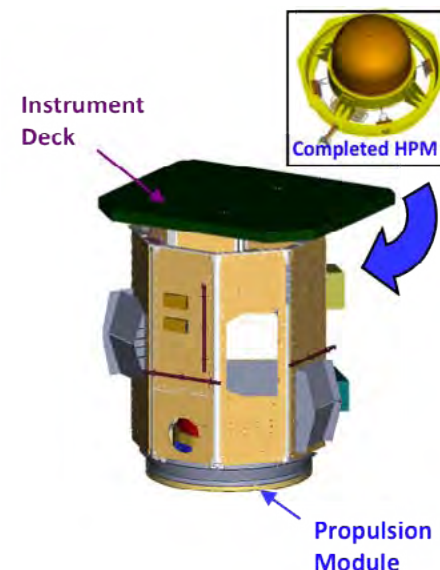

Test the system

Complete the sensor



Test the sensor

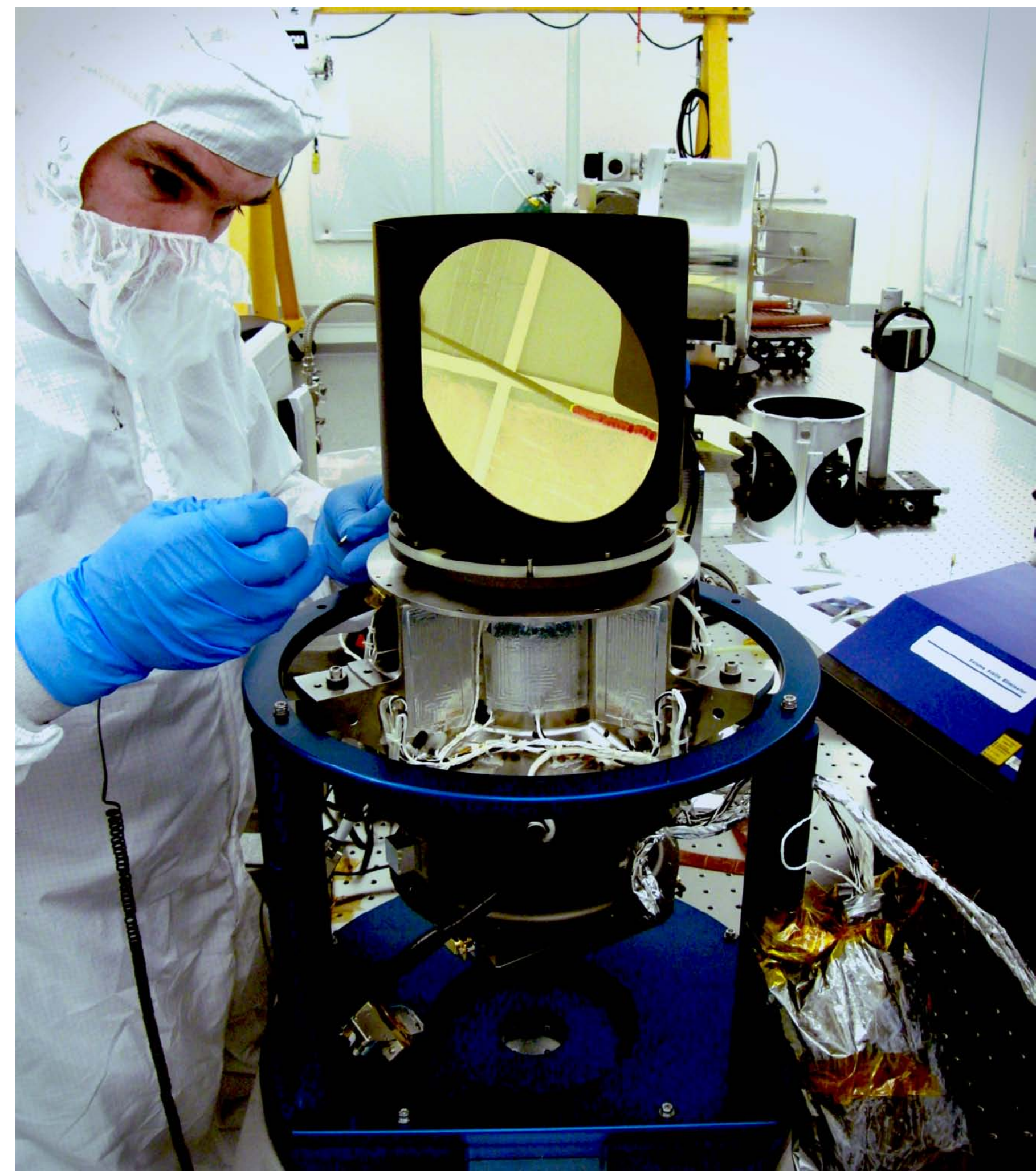

A NASA engineer integrates components of the TIRS sensor wearing a protective "bunny suit" to minimize contamination.

Below, engineers cover the Thermal Infrared Sensor with insulation blankets in the final stages of assembling it.



"Never try anything in orbit you didn't test on the ground," says Systems Engineer Terry Arvidson. "Try to anticipate how you'll use systems on orbit, and make sure those scenarios are in the ground testing."

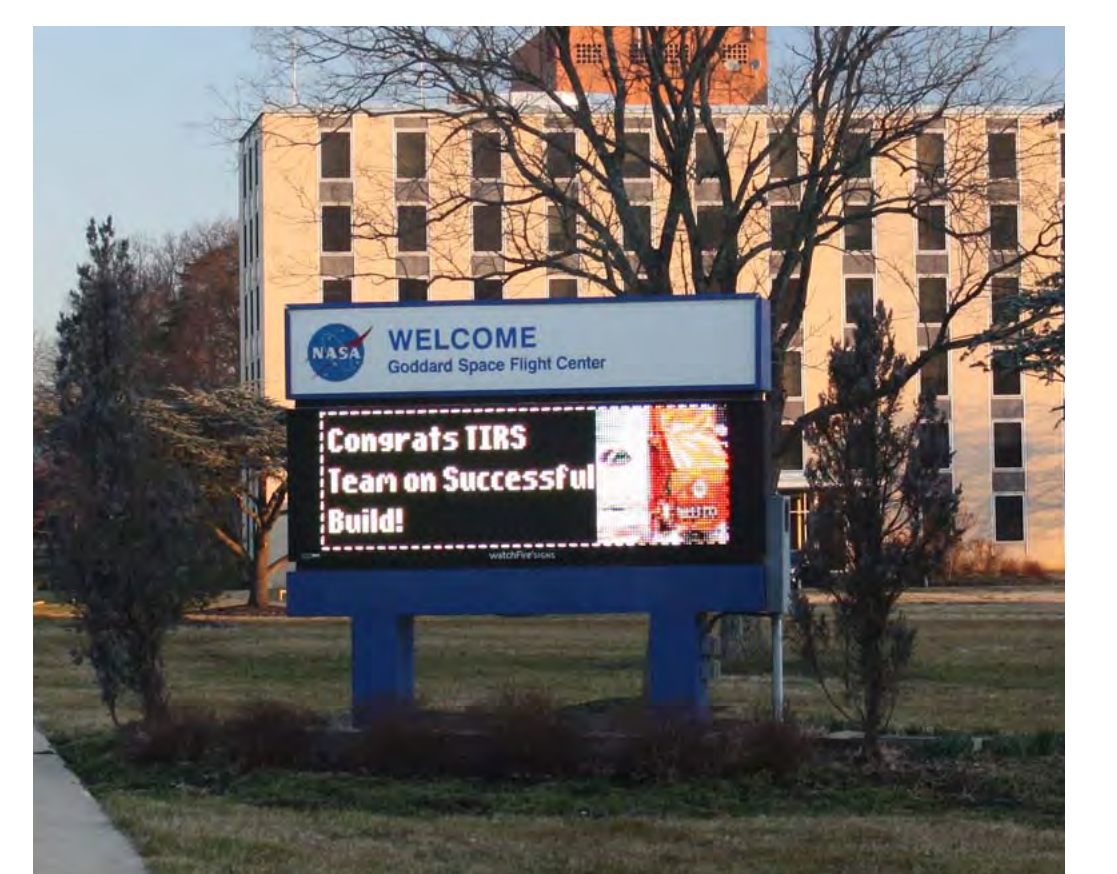



And Making Sure They Work

Will it survive vibration during launch?

Earth observing satellites are tested to make sure they can survive the extreme conditions of launch and operation in space. One kind of test involves bolting the observatory to a deck and shaking it harder than the launch will.



The "shaker table" at NASA Goddard Space Flight Center

Will it survive the pounding noise of launch?



In another test, the satellite sits surrounded by 144 rock concert speakers. During this acoustic test, the noise of thousands of pounds of exploding rocket fuel builds louder and louder until it blasts the satellite at a deafening 143.6 decibels – loud enough to cause serious damage and pain to unprotected ears. "I was outside the building when they did the full level acoustics [for the NPP mission]," says Glenn Iona, NPP Chief Engineer at NASA Goddard Space Flight Center, Greenbelt, MD, "and I could feel the ground shaking."

Will it survive the vacuum and extreme temperatures of space?

The spacecraft is built in Earth's atmosphere where air moves heat away from the warm instruments. How will the instruments function in a vacuum where there is no atmosphere? Without an atmosphere, the spacecraft will be subject to both extreme heat in direct sunlight and deep cold in Earth's shadow. How will the components expand and shrink? Will the temperature variation damage the spacecraft? To answer these questions, engineers put the instruments in an insulated vacuum chamber and test every variation in temperature without an atmosphere.

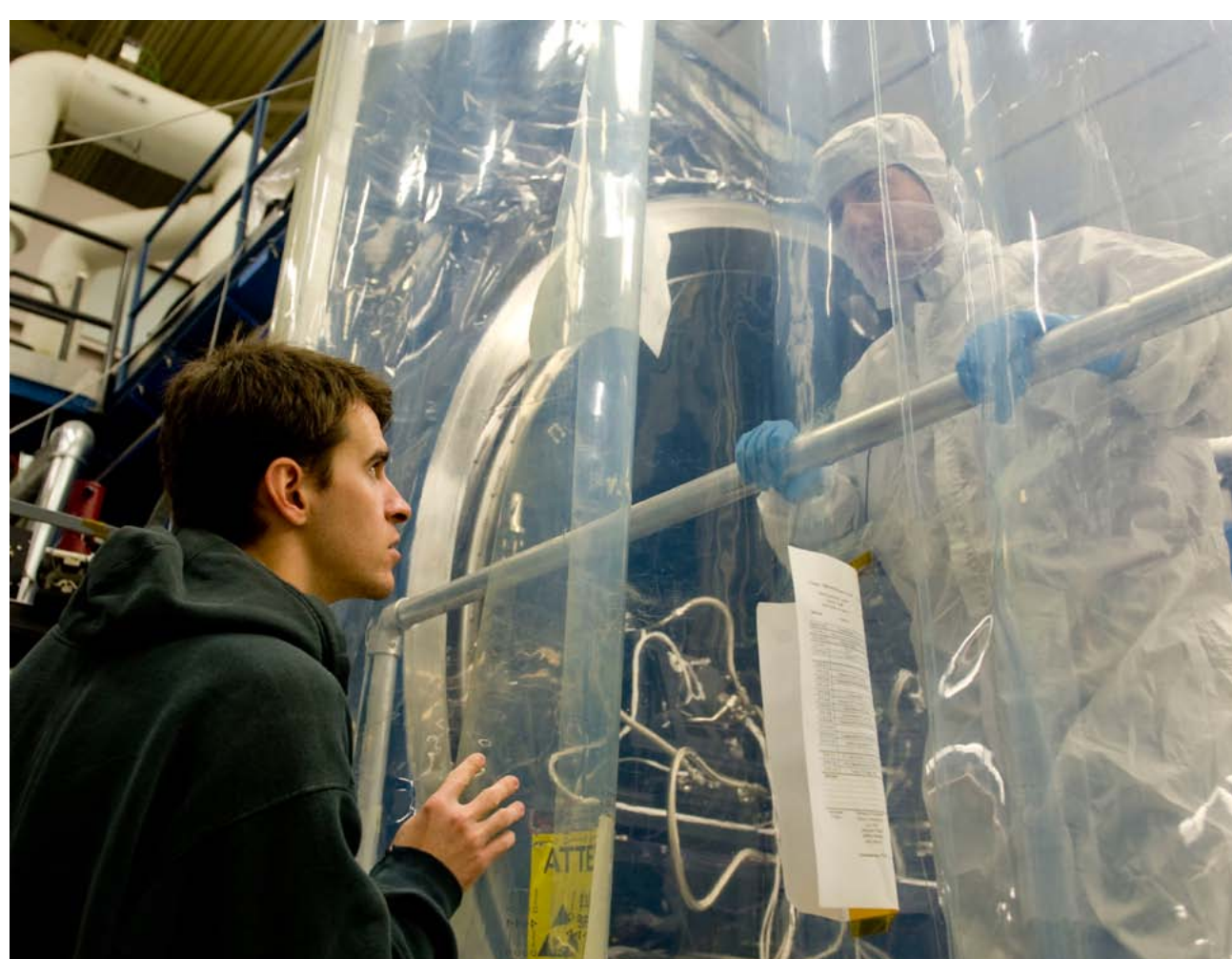

Everything must work during and after launch.

Coming Together

After each component is built, all of the pieces are shipped to Orbital Sciences Corporation in Gilbert, Arizona, to be assembled on the satellite frame.



In this series of photos, the completed Thermal Infrared Sensor (TIRS) is being packed into a special shipping container and put on a truck. The truck leaves NASA Goddard Space Flight Center in Greenbelt, Maryland on February 8, and arrives in Arizona two days later. Before the shipment, engineers placed a mass simulator on the truck and drove around the Washington, D.C. Beltway to test the stress the instrument would experience. They wanted to ensure that the packing material would keep the instrument safe. Assured that the packing material will work, they load TIRS onto the truck. The journey to Arizona is successful.





The LDCM Satellite



Ball Aerospace

The Operational Land Imager (left) is completed at Ball Aerospace in Boulder, Colorado, and shipped to Arizona to be added to the spacecraft.

Both TIRS and OLI are integrated onto the Landsat Data Continuity Mission frame by early March 2012. The photo below shows the instruments and spacecraft together for the first time.

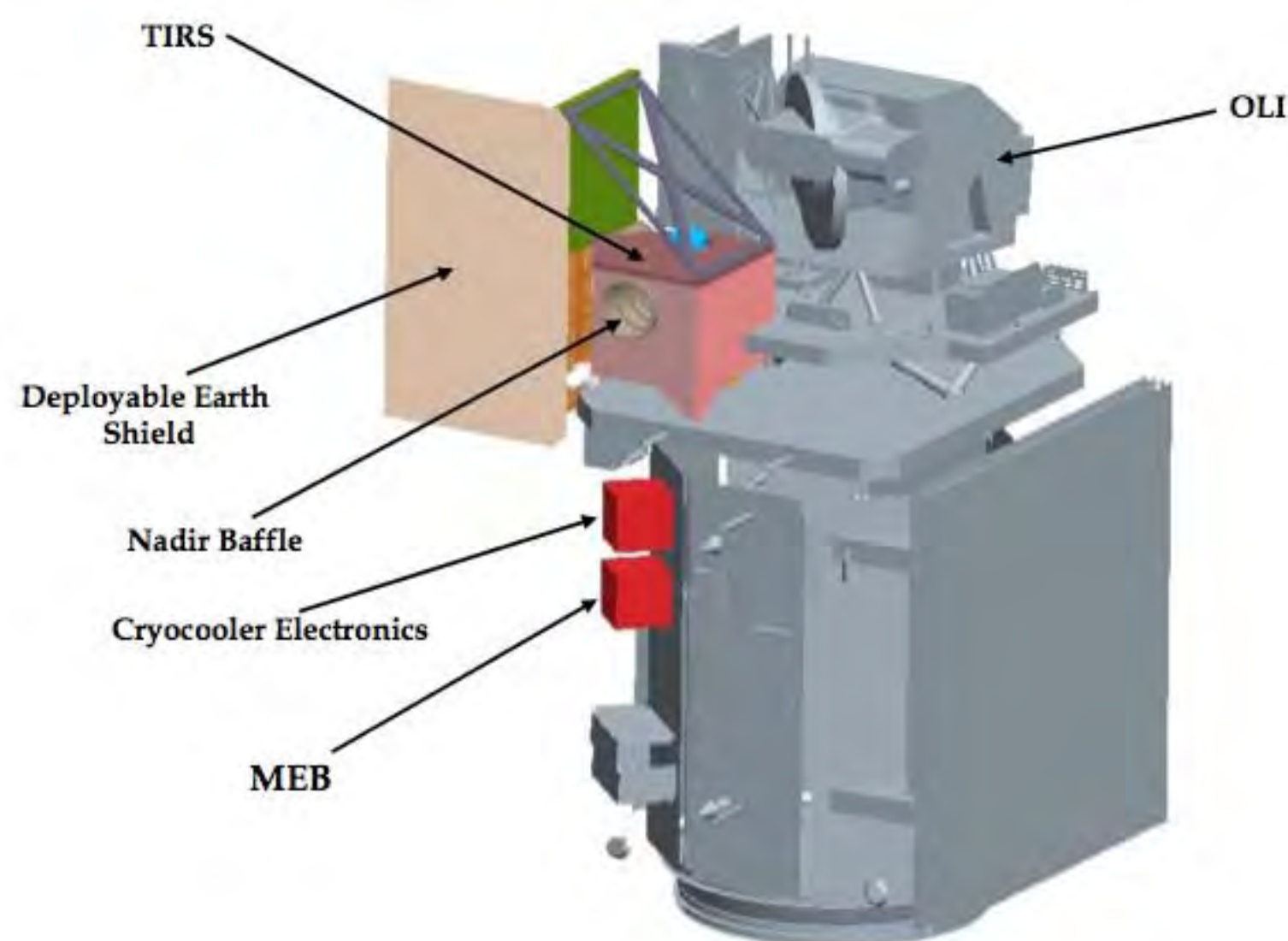

Orbital Sciences Corporation

COMMUNICATIONS

- S-band to GN/LGN: 1, 32kbps uplink; and 2k, 16k, 32k, or 1 Mbps downlink
- Omni antennas
- TDRSS - SA: 1 kbps return and 2 or 32 Kbps forward
- X-band: 384 Mbps science data

PROPULSION

- Hydrazine blow-down propulsion module
- Eight 22N Redundant Thrusters

GUIDANCE, NAVIGATION & CONTROL

- 2 of 3 star trackers active
- High precision IRU
- Honeywell reaction wheels
- SADA with damper
- 3-axis stabilized
- Zero momentum biased

THERMAL CONTROL

- Passive with heaters
- Constant conductance heat pipes (if needed)

STRUCTURE

- Aluminum primary structure
- Externally mounted components
- Clear instrument FOVs
- Clear instrument radiative paths



ELECTRICAL POWER

- Single wing single axis articulated GaAs solar array provides 4300 W at EOL
- 125 amp-hour NiH₂ battery
- Unregulated 22 V - 36 V power bus
- Two power distribution boxes

COMMAND & DATA HANDLING

- cPCI architecture; RAD750 CPU
- 3.1 Tbit (BOL) solid state recorder
- 265 Mbps peak OLI data transfer
- 26.2 Mbps peak TIRS data transfer
- High rate PB at 384 Mbps

Courtesy Orbital Sciences Corporation

Launch: January 2013

The Landsat Data Continuity Mission is scheduled to launch from Vandenberg Air Force Base, California, in January 2013. An Atlas-V rocket will carry LDCM into space.





Flight Operations

After launch, the Landsat Data Continuity Mission will be renamed Landsat 8. The United States Geological Survey will control flight operations, data collection and data distribution.

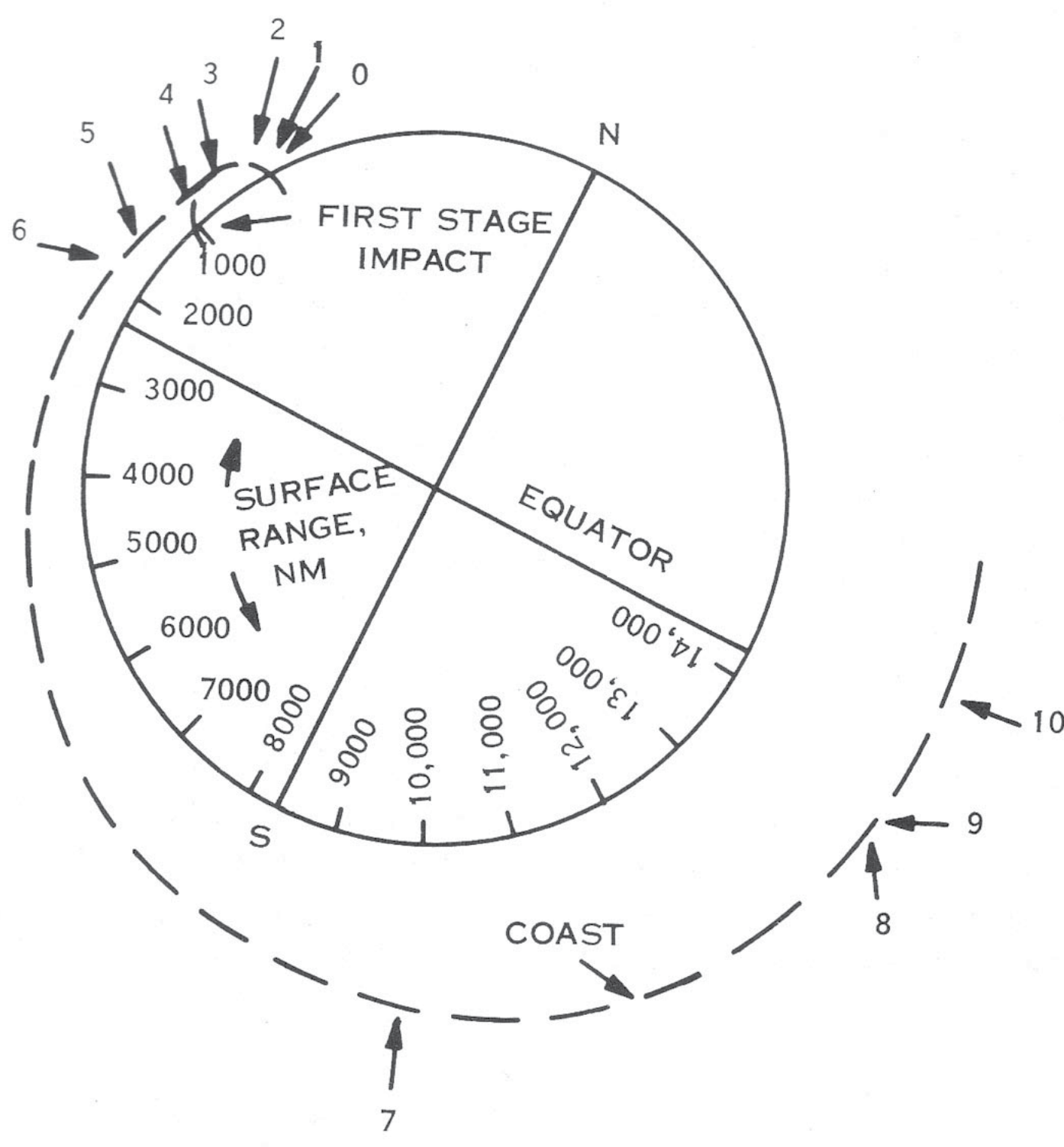

Landsat 8 will orbit from north to south during the day, crossing the equator at about 10 a.m. local time. It will fly 705 kilometers (438 miles) above the Earth.



Engineers will monitor the satellite 24 hours a day, 7 days a week. They will move the satellite if debris threatens it or if it drifts out of its ideal orbit.



These engineers are monitoring NASA's Aqua spacecraft during one such maneuver in the satellite's mission control room at NASA Goddard Space Flight Center.

Photos courtesy William Hrybyk, NASA Goddard Space Flight Center

The US Geological Survey will operate Landsat 8, but the mission control center will be at NASA Goddard.

Receiving stations operated by USGS will collect data from Landsat 8. Data will be processed and distributed at the USGS Earth Resources Observation and Science (EROS) center in Sioux Falls, South Dakota. All Landsat data are available at no cost.



Free Data for a Free Society

Every day Landsat provides essential information for decision makers, to support wise decisions about people and economies in the places we live and work.

Managing our forests



Protecting ecosystems and biodiversity



Producing food more efficiently

Conducting climate research



Copyright: Ylennik Egede Lassen/Alpha Film



Landsat in your Community

...maintaining human health ... monitoring and mitigating harm from disasters ... tracking urban growth ... and managing our energy and water resources in a multitude of ways.



Monitoring and mitigating the impacts of natural disasters



Supporting human health



Helping to locate sources of energy



Managing our water resources



1973

Tracking urban growth

Dubai, 1973-2006

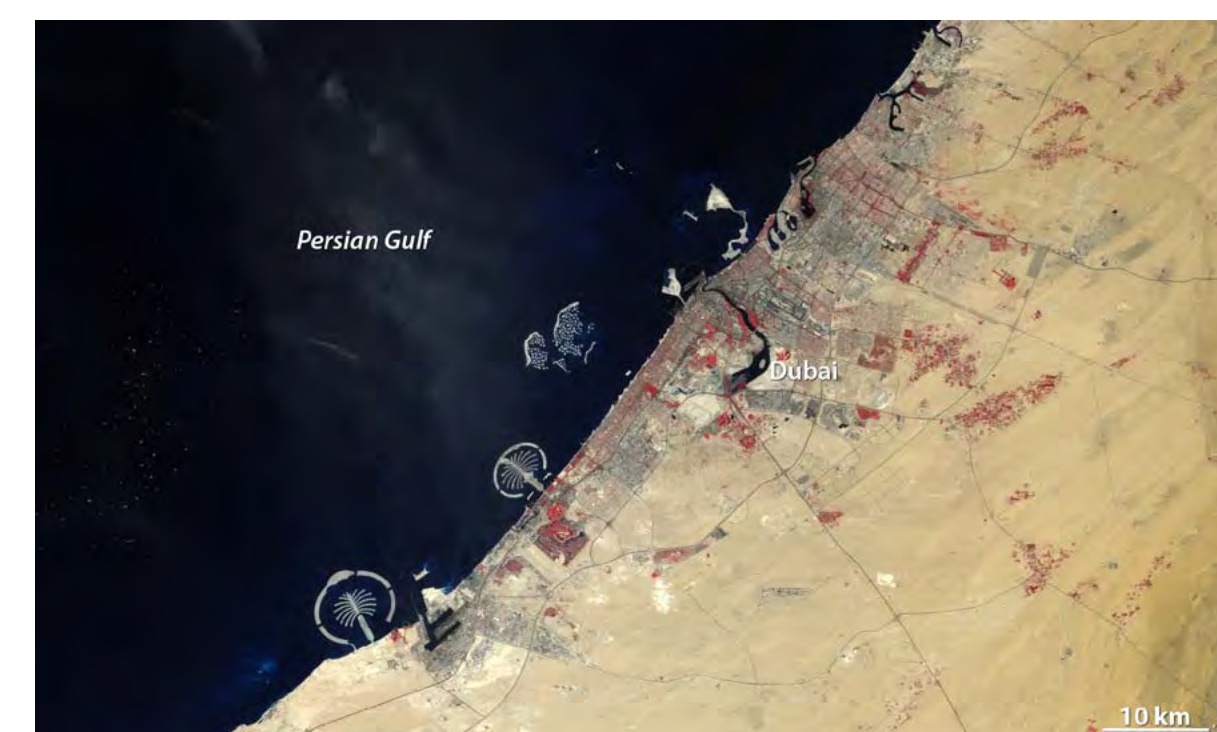

2006

Engineering Careers

Engineers use their education, on-the-job training, and creativity to invent, design, and build things to solve practical problems. NASA engineers are team players who think very carefully and independently.

Communications Engineer



Mechanical Engineer



Materials Engineer

NASA's work is done by teams of engineers with different specialties who work together to solve problems.

Managing Engineer



Thermal Engineer

Optical Engineer

Software Engineer



Design Engineer



Optical Engineer



Electrical and Electronics Engineers

Systems Engineer

Test Engineer





Engineering and You

*"Scientists discover the world that exists;
engineers create the world that never was."
Theodore Van Karman, aerospace engineer*

Study

Math

Science

Language Arts

Foreign Languages

Computer Science



People who grow up to be engineers tend to be curious about how things work.



If you decide that a career in science or engineering is for you, don't give up when obstacles arise, as they always do. Engineers must be determined and persistent. Other people just like you have made it, and so can you!

Meet the Engineers

Jeanine Murphy-Morris

LDCM Observatory Manager, NASA



What do you do?

I manage the contracting company that builds the LDCM spacecraft for NASA, and I coordinate with the systems engineers and test engineers to make sure the Observatory works as it should before it gets launched.

What do you love most about your work?

I get to work on something that I know will help people once it's sending data to us on Earth. And everyone I work with really likes what they do, which makes it very easy to go to work every day!

What education degree or credential do you have?

I have a Bachelor of Science degree in Aerospace Engineering and a Master's degree in Applied Remote Sensing and Geoinformation Systems.

What were your favorite courses during your academic career?

My favorite undergraduate classes were in aerodynamics and flight structures. It still makes me feel good to know why I'm very safe in an airplane!

Philip Dabney

LDCM Instrument Scientist, NASA



What do you do?

I translate "science speak" for engineers and "engineering speak" for scientists, to help the two groups communicate with each other. In other words, I work to understand the measurements the scientist want or need to make, then use my knowledge of physics and engineering to translate that into requirements that engineers can understand and use to build the instrument. While the instrument is being designed and built, I translate engineering language about how the operation of built instrument will affect the science measurements, so the scientists will understand that.

What do you love most about your work?

I love most applying a broad range of physics, science applications, and engineering disciplines to solve an important problem. LDCM is important!

What education degree or credential do you have?

I have a Bachelors Degrees in Physics and Electrical Engineering and a Masters of Science in Electrical Engineering with an Electro-Physics emphasis.

What were your favorite courses during your academic career?

My favorites were Calculus, Dynamics, Semiconductor Physics, Lasers and Electro-Optics, and Electromagnetics.

What is one thing you love to do aside from your professional work at NASA?

I ride a single-track mountain bike!



Who Designed & Built LDCM

Frank Grochocki

Principal Optical Engineer, Ball Aerospace & Technologies Corp.

What do you do?

I am an optical engineer by training and perform a specialized type of optical analysis called stray light analysis. This type of analysis is responsible for minimizing the amount of unwanted optical radiation (light) that gets to a detector.

What do you love most about your work?

The part of my work that I enjoy the most is the multidisciplinary and system level view of the instrument that is required. The type of analysis that I perform requires pulling together optical, mechanical, and detector details and knowledge into one mathematical model.

What education degree or credential do you have?

I have a Bachelor of Science degree in Optical Engineering from the University of Arizona College of Optical Sciences.

What were your favorite courses during your academic career?

My favorite courses were the optoelectronic device physics courses, which covered lasers and detectors, among other topics. Courses on geometric optics and radiometry were very beneficial to my current type of work as well. Geometric optics covers the building blocks of optical engineering such as lens design and image forming calculations. Radiometry is the study of the measurement of optical radiation and its sources.



Kimberly Hawkins

LDCM Software Manager, NASA



What do you do?

It's my job to make sure there's no bug in the software that would cause the spacecraft to fall from the sky. We can fix small bugs on orbit and still get the science data, but I have to make sure that the spacecraft and instruments are safe during those times of fixing software, and that we can get that fix loaded.

What do you love most about your work?

I love to touch things that go into space. Sometimes I get to work with the hardware, and it's really cool to be in the same room with it! It's even cooler to sit at a NASA console on launch day or even to be at the launch site, and to see years of work lifting into space.

What education degree or credential do you have?

I have a Bachelor of Science degree in Physics with a minor in Mathematics.

What were your favorite courses during your academic career?

Of course my favorite courses were physics and math. But I loved practical physics like engineering physics, electronics labs, classical dynamics, and computer programming.

What is one thing you love to do aside from your professional work?

When I'm not at work, I'm either riding my horses, training my dogs for obedience, or hanging out with friends at the lake.



Landsat 8 Launches January 2013



Follow us

<http://www.nasa.gov/landsat>

http://twitter.com/NASA_Landsat

<http://www.facebook.com/NASA.Landsat>

